



U-TECK™

Your Safety... Our Solutions.

2019
CATALOG

MUNICIPAL • TELECOM • HVAC • CATV • MUNICIPAL • BROADBAND • POWER • TELECOM • HVAC • C



Table of Contents

Splicing Solutions - Section A

Splicer Seat	A-1
Splicer Seat Accessories	A-1
Ergo Seat	A-2
Fiber Optic Protection Sleeve	A-2
Fiber Optic Splicing Workstation	A-3
Magic Wrap	A-4

Utility and Marking Identification - Section B

Temporary Fiber Drop Markers.....	B-1
-----------------------------------	-----

Mounting Equipment - Section C

Fire Retardant Interior Backboards	C-1
Exterior Backboards	C-4
Brackets and Clamps	C-5

Worklights - Section D

LED Emergency Worklight System	D-1
LED Flare Kit	D-2
LED Dual Power Worklight	D-3

Gas Detection - Section E

P100	E-1
P400	E-3
Gold G2 (LEL)	E-5
HGX-2D	E-7
Total Support System	E-9

Confined Space Ventilation - Section F

UAF-1500 & 1500-230	F-1
UAF-3000	F-1
UAF-3000P	F-2
UAF-8000	F-2
UAF-M08-25	F-3
Accessories	F-3

Temporary Cable Protection - Section G G-1

Micro-Trench Tools - Section H

Micro-Trenching Tamper Tool	H-1
Micro-Trenching Clip & Insertion Tool ..	H-1

Underground Solutions - Section I

Buried Closures	I-1
SealGuard II Water Sealing Solutions ..	I-2

Ladder Safety - Section J

Universal Ladder Wedge	J-1
Rung Runner Ladder Caddy	J-2
Pole Mounted Ladder Bracket	J-3
Step Runner Ladder Caddy	J-3

Utility Locator Tools - Section K

Pack-Rat Locator Vest	K-1
CartMarker	K-2

Storage - Section L

5-Pocket Tool Pouch	L-1
6-Pocket Tool Pouch	L-1
Cable & Wire Storage Box	L-1
Reel-Deal Cable Caddies	L-2
Reel-Deal Single Line Pull Caddy	L-2

Umbrellas - Section M

Dielectric Umbrellas	M-1
Work Umbrellas	M-1
Umbrella Accessories	M-2

Worker Safety - Section N

Attic-Trax Walk Boards	N-1
Wheel Chocks	N-1
Safe-T Lid Temporary Covers	N-2
Versa Lid	N-3
Chain Hoists	N-3
Handi Hoist	N-3

Weed Control - Section O

Ped-Mat	O-1
Utility Pole Mat Kit	O-2

High Visibility Workwear - Section P P-1

U-TECK

Your Safety... Our Solutions.

P.O. Box 2484, Fayetteville, North Carolina 28302
 (800) 542-7011 • Fax: (910) 483-0784

www.UTECK.com



Splicer Seat

Features

- Extremely rugged
- Large sitting area
- Five-year warranty
- Convenient tool slot
- Today's material
- Available in grey and safety orange
- Old, accepted design
- Textured surface

U-TECK has combined a longtime, craft-accepted design with a new polyethylene material to produce a rugged splicer seat that can be warranted for up to five years.

With the U-TECK Splicer Seat, there is never a need for water treatment because it is waterproof. No need for painting, either; the color is molded into the seat. And no worries about splintering. It is ouchless! This seat can be drilled to attach other equipment, such as splicing machines.

U-TECK has even included a handy tool slot in the top to hold your tools, connectors, or other small items when you need them close at hand. Conventional splicing machines can be attached to the Splicer Seat. The unique design of the seat allows it to be used at three different positions for varied heights. The Splicer Seat also makes an excellent footstool. With this seat, you will never need to purchase a replacement again.



Ordering Information

Grey Splicer Seat **VPN: 55430**

Orange Splicer Seat

VPN: 55430-OR

Splicer Seat Accessories



MS2 Splicer Adapter

Fits on your MS2 splicing tool to easily attach and remove it from the Splicer Seat.

VPN: 55420



Tool Base Adapter

Assists you when permanently attaching your 710 splicing tool to the Splicer Seat. **VPN: 55450**



710 Splice Adapter

Fits on your 710 modular splicing tool to easily attach and remove it from the Splicer Seat. **VPN: 55500**



Splicing Mat

3 ft. x 4 ft. rugged, washable, reusable pad that covers the work area. Keep your jelly-filled cable out of the dirt, and you and your tools out of the mud and weeds.

VPN: 55430-MAT



Universal Splicing Head Adapter

Used to temporarily attach either a 710 or MS2 splicing machine to the Ergonomic Seat or the Splicer Seat. Can be mounted in several locations as desired by individual splicers. **VPN: 55460**



Retro Fit Kit

Allows the upgrade from the Splicer Seat to the Ergonomic Splicer Seat adapter, the Ergonomic Splicer Seat, and even the drill bits to drill the holes.

VPN: 55430-RETROKIT



Splicing Arm Base

Fits under your Splicer Seat to attach your modular splicing tool when you do not want to attach it directly to the Splicer Seat. **VPN: 55430-BASE**



Tool Saddle with Pockets

Thickly padded cushion in a weather-resistant cover. Comes complete with three large pockets for tools and materials.

VPN: 55430-CU-BLK



Tool Pouch

Keep your tools close at hand with a tool pouch that attaches easily to your splicer seat.

VPN: 55430-POC-A



Splicer Seat is also available in Safety Orange

The Work Center Ergo Seat

Features

- Anti-skid Bottom
- Convenient Tool Slot
- Seat Back and Cushion Area
- Textured Surface
- Tool Box for Handy Storage
- Swivel 360 Degrees
- All Hardware Is Stainless Steel
- Removes and Folds Up
- Seat Can Be Used with or without Back
- Provides Work Platform for Splicing Machine

U-TECK has taken a field-proven and craft-accepted design the Splicer Seat and incorporated it into The WorkCenter, the newly designed Ergo Splicer Seat workstation. The upper portion of this seat removes easily, making setup possible even in tight, hard-to-maneuver spaces.

The WorkCenter as a complete unit is available to be ordered, or you can purchase a simple kit that will retro fit the thousands of existing Splicer Seats that are being used by most companies today. This will result in a tremendous savings for your individual budget.

This multipurpose unit is also the toolbox that personnel are accustomed to, which lets them keep their tools and materials conveniently located during an entire operation.

U-TECK has also designed a new Universal Splicing Head Adapter for mounting splicing heads to the seat base. This adapter will accept virtually any splicing machine. It may be mounted in different locations to accommodate the preference of the individual splicer. This makes The WorkCenter a complete workstation.

Product	VPN	Product	VPN
Grey Ergo Seat	55430-SS	Orange Ergo Seat	55430-SS-OR
Ergo Seat w/Pouch	55430-SS-POC	Tool Pouch	55430-POC-A
Retro-fit Kit	55430-RetroKit		



Fiber Optic Protector Sleeve

U-TECK's Fiber Optic Protector Sleeve was developed to protect and strengthen fusion splices on fiber optic cables.

The construction of the three protective and strengthening elements of the Fiber Optic Sleeve is distinctive in the function that each provides.

The inner stainless steel pin keeps the sleeve rigid and stable. The pin is vibratory tumbled with a special medium. This eliminates the possibility of fiber scarring or material penetration, both of which could damage the

sensitive glass fibers.

The inner tube is made of a specially designed material that compresses. The fiber splice becomes encapsulated within the inner tube.

The outer tube is manufactured of a heat-shrinking polyolefin. This encloses the inner tube and the encapsulated fiber splice, providing double protection and ensuring that moisture and air are eliminated from the fiber splice.

U-TECK's Fiber Optic Protector Sleeve is available in a standard length of 2 3/8" and is adaptable to all standard organizers; however, other lengths are available upon request. (Each package contains 50 sleeves)

VPN: 55501



Fiber Optic Splicing Workstation

Features

- Portable workbench
- Compact fold-up
- Heavy duty steel legs
- Quick-attach standoffs for hanging
- Large work surface
- Built in slots & holes for tools
- Cable management bracket

U-TECK is proud to offer the next generation fiber splicing workstation to support fiber splicing at the splice or optical network terminal (ONT). The NEW! Fiber Optic Splicing Workstation has a larger work surface, but offers the ability to fit in most work sites. It can be used as a freestanding workbench or in narrow manhole environments, inside tents, central office work, and light enough for aerial work in a bucket or attached directly to the cable support strand by removing the work surface from the stand.

The heavy duty, steel legs lock firmly to the work surface

and stands at a generous 31-1/2 inches tall, keeping your table at a comfortable working level. Our unique Cable Management Bracket fits securely on either side of the workbench, allowing jacketed strands to stay put and separated until you need them.

Separate the work surface from the stand and quickly attach the two unique stand-off props with adjustable webbing into the 4 accessory slots and you can take your work table to new heights, giving you a secure and level work surface when hanging it over terminal casings inside data rooms, closets, and outdoors against a wall for wall-mounted ONT's or NID's.

Attach the Aerial Strand Cables into the 4 accessory slots and your table is right where you need it for work at the cable support strand while working from an aerial bucket truck.

The Workstation surface area is approximately 35-1/2" x 22-1/2", with an inside recessed area of 22" x 18" and a weight capacity of 100 lbs. Slots and holes are molded into the table to conveniently hold tools, parts, splicing sleeves and other splicing equipment. This recessed area prevents small pieces from rolling off. The table folds up neatly for quick and easy transport and storage.

If you use the Workstation with the table top, floor stand and cable management bracket, it will weigh in at 17.63 lbs.

Hanging the Workstation using just table top, stand-offs, and the cable management bracket, the total weight is a mere 10.27 lbs!

No matter where your fiber splicing duties take you, you'll want to have this lightweight Workstation available at all times. Durable, portable and stable, this will become a standard in your splicing environment.

Workstation with floor stand, cable management bracket, and stand-offs **VPN: 55701**

Workstation with floor stand and cable management bracket **VPN: 55706**

Accessories shown on the next page.



Fiber Optic Splicing Workstation - Accessories



Fiber Splice Case Stand
VPN: 55712
 10 lbs



Black Poly-Mesh
 3-Pocket Pouch
VPN: 55710
 .15 lbs



Tablet Holder
VPN: 55720
 1.71 lbs



Stand-Offs
VPN: 55711
 2.4 lbs



Aerial Strand Cables
VPN: 55715
 1 lb



Splice Tray Holder
VPN: 55725
 .51 lbs



Wheel Kit
VPN: 55740
 10 oz



Splicer Seat Tether
VPN: 55745
 5 oz



LED Light with
 Magnifying Glass
VPN: 55615
 1.45 lbs



Magic Wrap ®

EMERGENCY REPAIR KIT ON A ROLL

Magic Wrap is an Emergency Repair Kit on a Roll. A poly-butyl rubber compound, Magic Wrap is activated when stretched. This activation causes Magic Wrap to adhere to itself. Thus, any object which can be spiral wrapped can be repaired or sealed.

Magic Wrap is ideal for use on dirty or wet surfaces. Because there is no adhesive, there is no reason that dirt or moisture will cause it to fail. Repairs can even be done underwater.

Magic Wrap is ideal for the following repairs:

- Automotive- will repair engine hoses, even fuel lines (to repair fuel lines, the white liner must be used first, then the Magic Wrap over top of the white liner. The white liner prevents any reaction between the fuel and Magic Wrap.)

- Electrical - UL listed
- Plumbing - works on copper and PVC pipes under pressure - no need to turn off the source of water
- Sealing, waterproofing, splicing, covering, holding/bundling, joining, and repair applications
- General Household repairs
- Sporting Goods - grips for hockey sticks, tennis rackets, fishing rods

Product

1" x 16' Magic Wrap Roll
 2" x 16' Magic Wrap Roll

VPN

UT-80001
UT-80031P



Temporary Fiber Drop Marker

FEATURES

- Quick, easy, light weight
- 2.5" in diameter
- Highly visible fluorescent orange acrylic material
- Protects expensive cable drops prior to trenching
- Reusable

When new communication services are installed at a location, often a temporary cable is placed on the ground and left until such time as a crew can come and permanently bury the cable in the ground.

This leaves the cable vulnerable from damage caused by vehicle traffic, mowers and people tripping on the cable, not aware of its presence.

U-TECK has developed a temporary solution to this problem.

Our markers are made from a Highly Visible Fluorescent Orange Acrylic material that enhances the visibility of the cable and helps reduce damage that might occur. Each marker is 2.5" in diameter.

Simply insert the staple pin onto the marker disc with the message side up, straddle the cable with the marker, and push firmly into the ground. The arrow indicator should align with the direction of the cable. Space markers adequately for best results.

U-TECK's Temporary Fiber Drop Markers are meant to be reused. You can also have your company logo added to the markings.

ORDERING INFORMATION

VPN	DESCRIPTION	QUANTITY
55360	Temporary Fiber Drop Marker	25/pack 100/box



Interior Fire Retardant Backboards

U-TECK has been a proud supplier of approved backboards for many years, allowing you to keep ahead of customer demand for fiber technology through continuing FTTX deployment. As a major OSP tool provider supplier, U-TECK endeavors to make reaching your goals as easy as possible by offering quality, ready-to-install, mounting boards to fit all of your equipment mounting needs...what you need, when you need it!

Our backboards are constructed of ¾" AC grade interior plywood purchased from sustainable forest wood manufacturers. They have 4 pre-drilled mounting holes, are sanded and then painted with gray or white fire retardant intumescent paint. The board is Class "A" rated per ASTM E84 (testing documentation available upon request).

Our finished backboards are of the finest quality, and we have supplied backboards without any safety concerns or complaints regarding quality and reliability.

By specifying U-TECK Backboards, you can be sure you will uphold the quality and safety standards of your company while meeting today's construction guidelines.

Fire Retardant Certification

Offering the highest quality products available is always our top priority. This objective was never taken more seriously than when we were approached to produce a fire-retardant backboard for use with telecommunication equipment. While other manufacturers offer products using just the paint testing to prove fire retardancy, we aimed for a Class "A" rating for the entire backboard!



Class Rating Label Sample

We submit random backboards to an outside testing lab to continuously test our finished units using the Steiner tunnel test. This test is conducted in accordance with the ASTM International fire-test response standard E84, to ensure our finished products can be labeled as Class "A" rated, the highest rating available within that ASTM specification.

Every U-TECK Fire-Retardant Backboard comes with this Class "A" rating, along with the Class Rating Label affixed to each board! That makes ours the safest backboards available in the market today!

Backboards in Use



Specifications

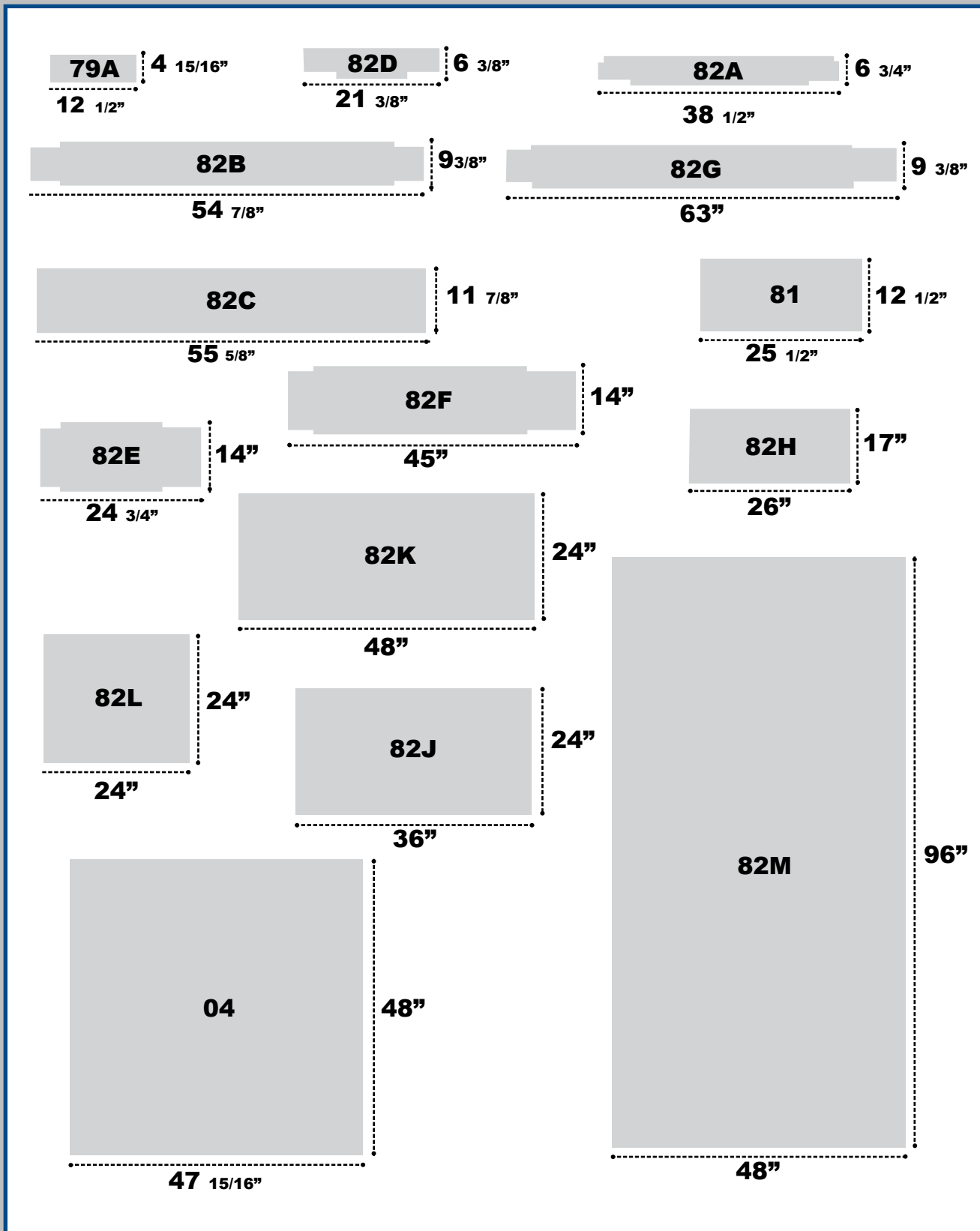

Ordering Information



Interior Fire Retardant Grey Backboards

Product Number	Model	Size
50104-FR	04	47-15/16" x 48" x 3/4"
501079A-FR	79A	4-15/16" x 12-1/2" x 3/4"
501081-FR	81	12-1/2" x 25-1/2" x 3/4"
501082A-FR	81A	6-3/4" x 38-1/2" x 3/4"
501082B-FR	82B	9-3/8" x 54-7/8" x 3/4"
501082C-FR	82C	11-7/8" x 55-5/8" x 3/4"
501082D-FR	82D	6-34" x 21-3/8" x 3/4"
501082E-FR	82E	14" x 24-3/4" x 3/4"
501082F-FR	82F	14" x 45" x 3/4"
501082G-FR	82G	9-3/8" x 63" x 3/4"
501082H-FR	82H	17" x 26" x 3/4"
501082J-FR	82J	24" x 36" x 3/4"
501082K-FR	82K	24" x 48" x 3/4"
501082L-FR	82L	24" x 24" x 3/4"
501082M-FR	82M	48" x 96" x 3/4"



Interior White Retardant Grey Backboards

Product Number	Model	Size
50104-FRW	04	47-15/16" x 48" x 3/4"
501079A-FRW	79A	4-15/16" x 12-1/2" x 3/4"
501081-FRW	81	12-1/2" x 25-1/2" x 3/4"
501082A-FRW	81A	6-3/4" x 38-1/2" x 3/4"
501082B-FRW	82B	9-3/8" x 54-7/8" x 3/4"
501082C-FRW	82C	11-7/8" x 55-5/8" x 3/4"
501082D-FRW	82D	6-34" x 21-3/8" x 3/4"
501082E-FRW	82E	14" x 24-3/4" x 3/4"
501082F-FRW	82F	14" x 45" x 3/4"
501082G-FRW	82G	9-3/8" x 63" x 3/4"
501082H-FRW	82H	17" x 26" x 3/4"
501082J-FRW	82J	24" x 36" x 3/4"
501082K-FRW	82K	24" x 48" x 3/4"
501082L-FRW	82L	24" x 24" x 3/4"
501082M-FRW	82M	48" x 96" x 3/4"

Shown above are our most common sizes...we have many more available and are able to manufacture custom size backboards to meet your specifications.



Exterior Backboards

Features

- Constructed from 3/4" impact resistant plastic
- Paintable and ready to install
- Low maintenance
- Moisture and termite proof
- A size for every job
- No grain raise or knots
- No splitting or cracking
- UV stable
- Meets UL94 5V, UL 1975 and has a flame spread of 20 according to ASTM E84

U-TECK recognizes the need for long-lasting material construction when choosing a backboard for outdoor use. Nature itself can be a brutal force, with outdoor backboards being exposed to fluctuating temperatures, rain, wind, and hours of direct sunlight. When you choose an outdoor backboard, choose one that will outlast standard wood backboards for years of low maintenance use.

Made from 3/4" impact resistant plastic, our Exterior Backboards are super tough and moisture proof. Available in any size configuration, this backboard will never rot, split or crack, yet can be drilled and painted like wood. It is perfect for any outdoor mounting use, including on cell towers to mount communication and power equipment.

Why mount your equipment to backboards that will need to be replaced due to constant weather exposure? Choosing the right tool for the job guarantees you'll save your company time and money.

Ordering Information

Please contact our Customer Service Representative at 1-800-542-7011 for a quotation. A sample of available sizes is located below, but custom sizes are available upon request.

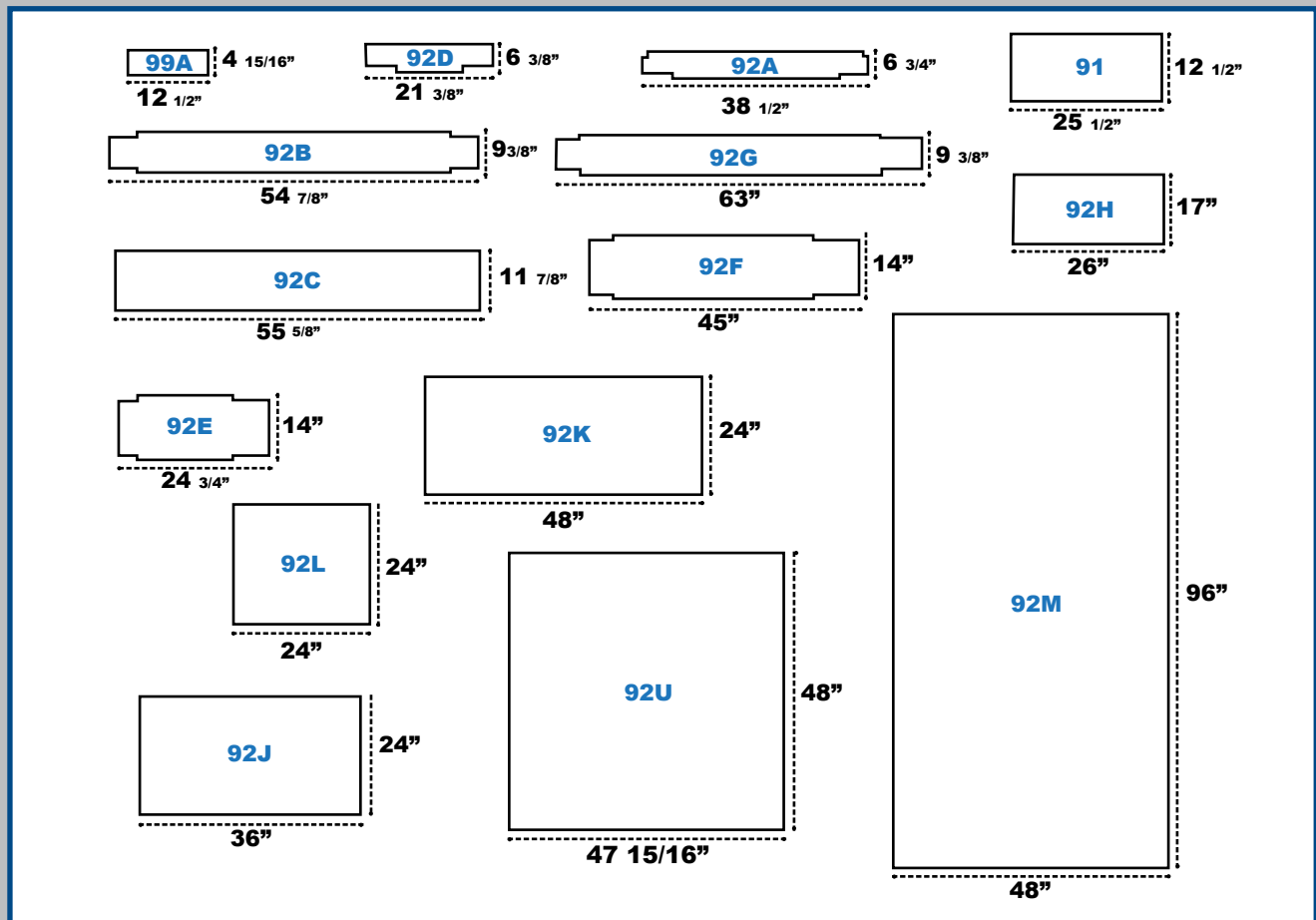

Mounting Brackets and Support Clamps



51B Hanger Brackets

Aluminum hanger brackets for mounting a wide variety of copper, coax, or fiber optics cable terminals and splice cases on building walls or on poles.

Product	VPN
Bracket 3.5" x 22" (allows direct attachment to exterior or interior wall studs on standard 16-in centers)	UT-T556-5
Bracket 3.5" x 27.5"	UT-T556-1
Bracket 3.5" x 33"	UT-T556-2
Bracket 3.5" x 40" (Designed for longer aerial terminals)	UT-T556-4
Bracket 5.5" x 40" (Provides additional stand-off for large diameter terminals)	UT-T556-3



Wall Mounting Brackets

Insure fast and secure placement of MC 12/40, CAD-12, and NCAD-12 closures on finished exterior walls. Various lengths allow proper stand off distance to clear obstructions. Galvanized steel, painted to match closure.

Product	VPN
Bracket for MC10/48 1"	UT-T484-1
Bracket for MC10/48 2"	UT-T484-2
Bracket for MC10/48 3"	UT-T484-3
Bracket for MC10/48 4"	UT-T484-4
Bracket for MC10/48 5"	UT-T484-5
Bracket for MC10/48 6"	UT-T484-6



Hardware Mounting for Fiber Snowshoe 4"

The Fiber Snowshoe is used to secure a tap or other electronic device to a strand. This product includes a bracket, set of mating jaws, a carriage bolt, and square nut.

VPN: UT-U500-1



Aerial Strand Hanger Brackets

Designed to support aerial closures and terminals when more than one aerial cable is carried by the strand. The bracket clamps to the strand, circles around the upper cable, and provides a strand-like rod to which the aerial closure may be attached. No complex adapters or special tools required.

Product

37 inch bracket
40 inch bracket

VPN

UT-T556-21
UT-T556-22



E Wall Bracket

The E Wall Bracket is used in conjunction with a one-bolt guy clamp for supporting strand on exterior walls where more than 3" of clearance is required between cable and wall. Bracket provides a clearance of 8".

VPN: UT-T639-3



S Wall Bracket

The S Wall Bracket is used to support strand on interior walls of either frame or masonry construction. Provide a 2" stand off from the wall.

VPN: UT-T639-4



Insulator Support Clamps

Used in conjunction with cable clamps, one-bolt guy clamps, and bridle rings for attaching to structural steel members such as H or I beams. Provides bonding point for mobile homes, trailers, etc.

Product

B Insulator Support
C Insulator Support

VPN

UT-B1420
UT-C3816

Packaging

10 each
10 each



C Beam Clamp

The C Beam Clamp is used for intermediate attachments of strand to the flange of a structural steel member.

Product

C Beam Clamp

VPN

UT-T5887

Packaging

10 each

Emergency Work Lights



Features

- 1,000 watts per set
- Heavy industrial construction
- Telescoping pole
- Fully adjustable tripod base

If you have an emergency and no light, be confident that U-TECK's Emergency Work Light System will provide you with everything you need to light up your work area. The Emergency Worklight System comes in a convenient carrying case with wheels. Just pick it up and go. Two sets of lights with all of the accessories to equal 2,000 watts of light can fit in one case.

The Emergency Work Light System from U-TECK emits up to 2,000 watts of halogen light at a 33% savings over conventional floodlight bulbs. The floodlights have a fully adjustable angle of light direction. Handles on the floodlights allow for safe adjusting and handling when the lights are hot. Each lamp has separate adjusting knobs for complete control of light direction.

The lampshade is a heavy-duty one-piece cast grill to protect the bulb but allow for easy bulb changing. The grill and hinge face are constructed of a material that will not rust.

The light system can be used with or without the heavy-duty industrial tripod. The tripod is fully adjustable, with each leg having its own height adjustment. Metal grips on the end of each leg eliminate the problem of not being on level ground. The telescoping pole extends to over 6 feet tall. Wide twist locks are used for easy height adjustment. Legs on the tripod fold for easy storage and transportation.

The cord is heavy-gauge and grounded for extra safety. There are also brackets on the base for easy cord storage.

Product	Description	VPN
Emergency Work Light System, Complete Kit	(1) set of 500 watt halogen lights (1) Carrying case with wheels (2) Extra bulbs in protective case (1) Bulb replacement tool (1) 50' heavy-duty extension cord (1) Heavy-duty industrial tripod with fully adjustable pole and legs	41000-LC
Emergency Worklight Kit	(1) set of 500 watt halogen lights (1) Heavy-duty industrial tripod with fully adjustable pole and legs	41000
Extra Bulb Set	(2) 500-watt halogen lamps (1) Bulb protective carrying case (1) Bulb replacement tool	40500-2
Extension Cord	(1) 50' heavy-duty extension cord	47555-50
Carrying Case	(1) Carrying case with wheels and rubber liner	41000-CC



Carrying Case
VPN: 41000-CC



Replacement Bulb Kit
VPN: 40500-2



Extension Cord
VPN: 47555-50

LED Flare Kit

Enhance Your Safety on the Road
with the Ultimate LED Flare

FEATURES:

- Night-time visibility of 3,500 ft. (1,066 m)
- Flashes per minute: 120
- Crush resistant up to 20,000 lbs. (9071.8 g)
- Durable Aluminum Alloy Housing
- Waterproof up to 15 ft. (4.57 m)

LED Flare Kit is being used by law enforcement, fire departments, construction workers, search and rescue teams, tow truckers, ground safety crews and many more who feel they require additional visible warning lights. The LED Flare is made of durable aluminum alloy, was made with longevity in mind. It has no switches or moving parts to break off or become damaged. It is weatherproof and waterproof up to 15 ft. The Lithium battery lasts for hours between charges. In addition, it will run on 110-240V, and can be customized for the different electrical outlet plugs for any particular country.

MODEL: FLAREKIT The LED Flare Kit Includes: 6 LED Flares, a Wall Charger, and Car Charger (specify lens color after model number)



SPECIFICATIONS:

- Unit Dimensions: 4.0"W x 4.0"L x 1.0"H (10.2cm x 10.2cm x 1.0cm)
- Kit Dimensions: 5.5"W x 9.5"L x 5.5"H (14cm x 24.1cm x 14cm)
- Unit Weight: 1 lb. (453.59 g)
- Kit Weight: 7.7 lbs. (3492.7 g)
- Battery Cycle: 6-8 hrs of continuous use, fully charged in 120 min.
- Battery Life: 2 yrs.*
- LED Brightness: 10 LEDs rated at 15,000 mcads per LED
- Car/Wall Chargers Included
- Working Temperature Range: Charging: 0°C to 45°C (32°F to 113°F)
Discharging Temperature Range: -20°C to 60°C (-4°F to 140°F)
Storage Temperature Range: -20°C to 40°C (-4°F to 104°F)

MODEL: LEDFLARE (can be purchased separately)



B = Blue

A = Amber

R = Red

Charging Indicator Lights



ECO-FRIENDLY

- Reusable - Replaces THOUSANDS of flares
- No perchlorate - won't contaminate ground water
- No toxic fumes released
- No residue or debris left behind



(Enlarged example of tread to show detail.)

LED Flare Kit/Duro-Flash® is a patented product, patent number 0565.755.

*Depends on storage.

CHECKERS®
INDUSTRIAL SAFETY PRODUCTS



Dedicated to saving lives and protecting assets

1-800-438-9336

www.checkersindustrial.com

DISTRIBUTED BY:

U-TECK™

(800) 542-7011

UTECK.com

Product

LED Flare Kit

LED Flare Kit Replacement (Amber)

VPN

U-LEDFLAREKIT-A

U-LEDFLARE-A



LED Work Lights

Features

- Uses super bright LEDs that are 50,000 hour rated for up to 30 years of use
- Portable, weather proof design with power-save mode
- Durable polymeric housing and high output mirror reflector
- Cool to the touch, great for indoor and outdoor use
- 10 year manufacturer's warranty

This Super bright LED worklight is 98% more efficient using 24 LEDs. It is designed to be portable and weatherproof with a durable polymeric housing and high output mirror reflectors.

This light is backed by a 10 year warranty. Perfect at home or work because of its cool to the touch design, great for indoors or outdoors.

Models are available in AC and rechargeable versions.

Product

24 Rechargeable LED Portable Worklight
 24 High-Power LED Worklight

VPN

UT-L1320
UT-L1323

FIND IT! WITH SENSIT[®] P100

the new sensit[®] p100 monitor will alert workers of dangerous levels of carbon monoxide, hydrogen sulfide or oxygen



ACTUAL SIZE
OF INSTRUMENT

**GREAT LOW PRICE!
LOWEST COST
OF OWNERSHIP!**

- 2 YEAR OPERATION
- SERVICEABLE SENSORS
- EASY CALIBRATION
- ONE BUTTON OPERATION
- AUDIBLE, VISUAL AND VIBRATION ALARMS
- LIMITED 2 YEAR WARRANTY (INCLUDING SENSOR)

PROTECT YOURSELF FROM HAZARDOUS GASES



- TO OPERATE:**
1. Press Power
 2. Wait 30 Seconds for Automatic Zeroing
 3. Begin to Use

Patented

SENSOR SPECIFICATIONS

TYPE	RESOLUTION	RANGE
O2	0.1%	25%
CO	1 ppm	0-999* (See Extended Display Option, Next Column)
H2S	1 ppm	0-100
HCN	0.1 ppm	0-30
Cl ₂	0.1 ppm	0-20
NO ₂	0.1 ppm	0-20
SO ₂	0.1 ppm	0-20

PRODUCT SPECIFICATIONS

Size:	3.81" x 2.31" x 0.8" (9.67 x 5.87 x 2 cm)
Weight:	3.6 oz. (105 g)
Operational Temp:	-4 to 104 F (-20 to 40° C)
Humidity:	15-90% RH (Non-condensing)
Power Source:	3.6V Lithium Battery
Battery Life:	2+ Years (May be less depending upon temperature & duration of alarm)



STANDARD KIT KIT OPTIONS

- | | |
|--------------------|-------------------|
| Belt Clip | Bump Test Station |
| Instruction Manual | Calibration Kit |

OPTIONAL FEATURES

- "Always On" Mode
- Infrared Communication
- Remote Sample Draw Assembly
- Aspirator with 10ft. Tubing and Probe

*CO Extended Display Option:
 Detection Range:
 0ppm - .2% Volume
 (2000ppm equivalent)
 Resolution:
 1ppm for 0 - 999ppm
 0.1% Volume for 1000ppm - 2000ppm



Class 1, Groups A, B, C, & D
 Ex ia
 Temp code: T4



Ex ia IIC T4
 AEx ia IIc T4
 IP65
 ATEX Cert. No.: TRAC 09 ATEX 11195X
 EMC Directive (2004/108/EC)
 EN 61000-4-2:1995, EN 61000-4-3:2002,
 EN 55011:2007

SENSIT[®] P400

MULTI GAS PERSONAL MONITOR

SENSIT[®] P400 features the Immediate Detection System (IDS); an early warning system to alert you as your environment changes.

When combustible or toxic gas levels are on the rise, the P400 will automatically alert you when the environment in your workspace starts to change. At multiple stages, customized settings stand guard to warn you as conditions worsen...**before** full alarm activation.

In Hazmat response or confined space work knowledge is safety. Stay safe with IDS.

Large, Easy to Read Display

Extremely Rugged Design

Immediate Detection System*

Extremely Fast Response

Simple Field Maintenance

Low Cost of Ownership

Many Sensor Options

Made In USA

Available Sensors

Oxygen (O₂)
 Carbon Monoxide (CO)
 Hydrogen Sulfide (H₂S)
 Hydrogen Cyanide (HCN)
 Nitrogen Dioxide (NO₂)
 Phosphine (PH₃)
 Sulfur Dioxide (SO₂)
 Ethylene Oxide (ETO)
 Combustible Gases

P400 Standard Features

- Audible Alarm - 3 Tone
- Visual Alarm - 270° View
- Vibration Alarm
- STEL and TWA Alarms
- Compliance/Status Indicator
- Data Logging
- Easy Field Calibration
- Easy Clean Dust Pre-Filter
- Easy-Access Reusable Dust Filter
- Alkaline and/or NiMH Battery
- Limited 2-Year Warranty (Including Sensors)
- Extended Warranty Available



INDUSTRY USERS

Utilities
 Maintenance
 Fire Departments
 Safety Inspectors
 Home Inspectors
 Water/Sewer Departments
 Heating Contractors
 Utility Contractors
 Industrial Plants
 Propane Marketers



APPLICATIONS

Oil & Gas Exploration
 Gas Contractors
 Emergency Responders
 Emergency Medical Personnel
 Confined Space



***Optional, Immediate Detection System (IDS) provides early warning to changes in gas concentrations.**

(Patent Pending)

*Contact Sensit Technologies for more info.



TO OPERATE:

1. Press Power
2. Wait 30 Seconds for Automatic Zeroing
3. Begin to Use

Patented

SENSOR SPECIFICATIONS

TYPE	RESOLUTION	RANGE	ACCURACY	RESPONSE T90 TIMES
LEL	0.1 - 2.0%	0-100	±10%	< 10 Sec
O2	0.1%	25%	±0.2% or 10%**	< 10 Sec
CO	1ppm	0-999*	±5ppm or 10%**	< 10 Sec
H2S	0.1 or 1ppm	0-100	±2ppm or 10%**	< 20 Sec
HCN	0.1ppm	0-30	±1ppm or 10%**	< 20 Sec
NO ₂	1ppm	0-250	±2ppm or 10%**	< 20 Sec
PH ₃	0.1ppm	0-10	±1ppm or 10%**	< 20 Sec
SO ₂	0.1ppm	0-20	±1ppm or 10%**	< 20 Sec
ETO	0.1ppm	0-10	±1ppm or 10%**	< 20 Sec

** Whichever is greater

PRODUCT SPECIFICATIONS

Size:	5.2" x 3.2" x 1.7" (13.2 x 8.1 x 4.0 cm)
Weight:	12 oz. (340 g)
Operational Temp:	-4 to 122 F (-20 to 50° C)
Humidity:	10-90% RH (Non-condensing)
Power Source:	4 "AA" Alkaline or NiMH Recharger Pack
Battery Life:	24 Hr. Alkaline or 15 Hr. NiMH
Sound:	98db @ 15" (30cm)



STANDARD KIT

- Belt Clip
- Instruction Manual
- Calibration Adapter
- Dust Pre-Filter
- Batteries
- Screwdriver
- Hex Wrench

KIT OPTIONS

- Carry Case Pouch
- Confined-Space Entry Kit
- Calibration Station
- Calibration Kit
- Recharger Battery Pack
- Recharger Station

OPTIONAL FEATURES

DS (Immediate Detection System) Pre-Alarm Indicator

High Performance Motorized Sample Pump with Filter and 10ft. Tubing and Probe Samples up to 100ft.

Remote Sample Draw Assembly Aspirator with 10ft. Tubing and Probe

Serial Communication

Stainless Steel Clip

*CO Extended Display Option:

Detection Range: 0ppm - 1999ppm



For Class 1, Division 1, Groups A, B, C and D Hazardous locations when used with approved alkaline batteries or rechargeable battery pack.

IP65

Temp code: T4, -20° C to 50° C



Ex d ia IIC T4, Gb, IP65
-20° C to 50° C
DEMKO 12 ATEX 1102012

SENSIT® GOLD G2

VERSATILE MULTIPLE GAS DETECTION INSTRUMENT

FIND GAS LEAKS FASTER

SENSIT® GOLD G2 is the most versatile and user-friendly SENSIT available. The "G2" can be configured for combustible gas readings in PPM, LEL and/or percent volume, as well as a variety of toxic sensors and oxygen.

The **SENSIT GOLD G2** is ideal for leak location and confined space applications. This instrument can also be used for inert gas operations to detect combustible gases in oxygen-free environments.

Displays Up To 4 Gases Simultaneously

- LEL (%Volume and PPM Optional)
- Oxygen
- Carbon Monoxide
- Hydrogen Sulfide
- Hydrogen Cyanide (Optional)

Selectable Gas Type

- Methane (Natural Gas)
- Propane



G2 Standard Features

- Internal Pump - Fast Sampling
- Digital "Tick" Control - Fast Leak Location
- Lowest Cost, Long Life Sensors
- LED Warning Lights
- Bright Graphic Display
- Loud Audible Alarm
- Battery Strength Indicator
- Internal Memory
- Exceptional Water Protection

INDUSTRY USERS

Gas Companies (natural & propane)
Gas Exploration & Transmission COs
Industrial Plants
Chemical/Petro Chemical Plants
Fire - Hazmat - Arson Services
HVAC Contractors

APPLICATIONS

Combustible Gas Leak Detection
Gas Leak Survey
Underground Leak Pinpointing
Carbon Monoxide Investigations
Confined Space Monitoring
Combustible Gas Measurements
Pipeline & Vessel Purging
Inert Gas Operations
Method 21 Emissions Testing

PARTIAL LIST OF GASES SENSED*

Butane
Carbon Monoxide
Gasoline
Hydrogen Sulfide
Methane
Natural Gas
Oxygen
Propane

*Contact Sensit Technologies for more info.



Patented

SENSOR SPECIFICATIONS

TYPE	RESOLUTION	RANGE	ACCURACY
PPM*	1 ppm or 10ppm	0-10,000 ppm	±10%
LEL	0.1% up to 2%	0-100% LEL	±10%
% NAT GAS	0.1%	5-100% GAS	±5%
% PROPANE	0.1%	2.2-100% GAS	±5%
O2	0.1%	0-25%	±0.2% or 10%**
CO	1 ppm	0-2000ppm	±5ppm or 5%**
H2S	1 ppm	0-100ppm	±2ppm or 5%**
HCN	1 ppm	0-30ppm	±1 ppm or 5%**

*PPM Optional
 PPM Ranges Available:
 0-2,000ppm, 0-5,000ppm, 0-10,000ppm

**Whichever is greater

PRODUCT SPECIFICATIONS

Size: 11.5" x 3" x 2.32" (29.2 x 7.6 x 5.9 cm)
 Weight: 1.2 lb. (544 g)
 Operational Temp: -4 to 104 F (20 to 40° C)
 Battery Life: Alkaline: Approximately 18 hrs. Continuous



STANDARD KIT

- Hard Carrying Case
- 3 "C" Batteries
- Extra Sensor Cap
- Choice of 2 Piece Bar Hole Probe or Confined Space Probe
- Wrist Strap
- T10 Allen Wrench
- Instruction Manual

OPTIONAL FEATURES

Data Logging Options:

- 100 Instant Event Saves
- 1600 Auto Log Saves
- 100 Bar Hole Tests

ADDITIONAL FEATURES

Bar Hole Test Features:

- Peak Readings
- Sustained Readings
- Timed Test

Adjustable Calibration Reminders:

- Calibration Due
- Calibration Over-Due (Shows at Startup)

Adjustable Gas Scales:

- Auto Range Point for LEL to %Vol

Gas Identification Alert Options:

- "NSR" - Non-Standard Response
- "NSC" - Combustible Other Than Gas Calibrated to (4-5% Volume)

ATEX Cert. No. TRAC11ATEX21304X



Ex ib IIB T3
 AEx ia IIB T3
 IP54

CERTIFICATE ISSUED BY:



UL Listed UL 913

Intrinsically Safe for Use in Class I, Groups C and D, T3 Hazardous Locations

SENSIT[®] HXG-2d

COMBUSTIBLE GAS LEAK DETECTOR

SENSIT[®] HXG-2d is the first affordable gas leak detector with a true digital display, because knowing exactly how much counts! The HXG-2d is intrinsically safe, durable and reliable. It's new patent pending electronic tick control is ideal for locating Natural, Propane and Butane gas leaks quickly.

No More Guess Work

- Direct PPM Readout 0-990 ppm
- Direct LEL % Readout 0-100% LEL

Digital Tick Control Finds Leaks Faster

HXG-2d Standard Features

- Push-Button Operation
- Field Calibration
- Backlit Display
- Adjustable Alarms
- Long-life, Low-Cost Sensor



INDUSTRY USERS

Utility Companies
 Gas Processing Plants
 Propane Marketers
 Safety Engineers
 Fire and Police
 Emergency Vehicles
 Appliance Repair
 Plant Maintenance
 Plumbing Contractors
 Furnace Heat Exchanger Testing
 Marine Operations
 Heating and Air Conditioning
 Municipalities
 Mobile Home Parks
 Apartment Buildings



APPLICATIONS

Confined Space Monitoring
 Vessel Testing
 Manhole Entry
 Vault Entry
 Leak Detection
 Leak Pinpointing
 Pipeline Purging



PARTIAL LIST OF GASES SENSED*

Acetone	Industrial Solvents
Alcohol	Jet Fuel
Ammonia	Lacquer Thinner
Butane	Methane
Ethylene Oxide	Natural Gas
Gasoline	Propane
Halon	Refrigerants
Hydrogen	

The SENSIT[®] HXG-2d cannot be used to check for carbon monoxide (CO) leakage.

*Contact Sensit Technologies for more info.



STANDARD KIT

- Carrying Pouch
- 3 "C" Batteries
- T10 Allen Wrench
- Instruction Manual

KIT OPTIONS

- Probe Assembly
- Wrist Strap
- Calibration Kit

OPTIONAL FEATURES

Rechargeable Battery:

- NiCad Batteries
- In-Unit Charging
- Universal "Multiple-County" Charger

SENSOR SPECIFICATIONS

TYPE	RESOLUTION	RANGE	ACCURACY
PPM*	1 ppm or 10ppm	0-990 ppm	±10%
LEL	0.1%	0-100% LEL	±10%

*PPM Optional

PRODUCT SPECIFICATIONS

- Size: 3.5" x 10" x 1.6" (8.9 x 25 x 4 cm)
- Weight: 1.3 lb. (0.59 kg)
- Operational Temp: -4 to 104° F (20 to 40° C)
- Battery Life: Alkaline: Approximately 50 hrs. Continuous

Designed to meet Europe



Ex ib IIB T3
IP20

Designed to meet USA
Class 1, Division 1, Groups C and D, T3

Designed to meet Canada
AEx ib IIB T3

Total Support System (TSS)

Features

- Verify and adjust to correct detection levels with factory certified calibration gases.
- Check all lights.
- Check all audio alarms.
- Check all sensors.
- Check for broken or damaged parts.
- Replace batteries.
- Verify that correct check gas is being used by craft personnel
- Make minor repairs.
- Quick Check training.
- Verify that correct accessories are being used.
- Record serial number and location.
- Supply additional training as needed.
- Explain laws and rules for manhole or confined space testing.



OSHA requires that all gas detectors be tested and certified to be accurate once a year.

U-TECK provides factory trained personnel to support all of our gas detectors.

In order to assist our customers, U-TECK offers a unique service called the Total Support System (TSS). Most of these services can be performed on your premises with minimal work interruption.

All you have to do is call U-TECK at 1-800-542-7011 to schedule factory trained personnel to visit your location. If any unit is found to require more intensive repairs, they will note this on the itemized bill for you to handle per your company policy.

If a unit is found to be in need of repair, an attempt will be made to fix the unit on your premises. In many cases, units can be repaired in this way. For these repairs, you will be charged only for the parts. The labor is covered under the T.S.S. charge when these minor repairs are made on-site.

For units that cannot be repaired on-site, we offer a complete repair program. Staffed by authorized, factory trained personnel, our repair department can quickly review your unit and repair it accordingly.

Billing

The TSS program is charged on a per-unit basis. At the time of certification, an itemized bill is made out and then given to the supervisor for approval and signature.

Payment options might include customer billing with a purchase order or payment by MasterCard, Visa or American Express.

Our Commitment to Service

U-TECK continually strives to provide complete service to our customers on all products we produce and market.

This commitment to excellence is especially important when it comes to our gas detectors, where safety and loss of life are a possibility.



Light Industrial and Utility Ventilators

Features

- CFM rating of 877
- Lightweight, only 18 lbs. (8.2kg)
- Stackable to save storage or work area space
- Available in “safety yellow” for high visibility
- Capability to connect up to 50 feet (15.24m) of straight duct
- Ideal for manhole applications
- UL & CUL listed

For a versatile portable ventilator with just the right amount of power, the UAF-1500 or 1500-230 (blower extractor) is ideally suited for light industrial or utility applications.

Perfect workhorses for small confined spaces such as manholes or sewers, these compact blowers deliver maximum airflow for a safe, comfortable, and controlled work environment. Your construction, utility, or telephone crews can depend on the UAF-1500 or 1500-230 to deliver a continuous flow of fresh air to blow and extract toxic or noxious gases.

VPN: A-1500

VPN: 1500-230

DIMENSIONS

MODEL	•1500	•1500-230
Fan Type	Axial Blower/Extractor	Axial Blower/Extractor
Size	8" dia. (203mm)	8" dia. (203mm)
Weight	18 lbs. (8.2kg)	18 lbs. (8.2kg)
Height	18.5" (470mm)	18.5" (470mm)
Length	18.5" (470mm)	18.5" (470mm)
Width	12.5" (318mm)	12.5" (318mm)

AIR FLOW RATES

MODEL	•1500	•1500-230		
	CFM	M ³ /Min.	CFM	M ³ /Min.
Free Air	877	24.8	749	21.2
15' Straight	610	17.3	510	14.4
25' Straight	597	16.9	508	14.4
40' Straight	518	14.7	460	13.9
50' Straight	460	13.0	443	12.5
25' 1-90 bends	533	15.1	464	13.1
25' 2-90 bends	508	14.4	435	12.3



Industrial Ventilator

Features

- CFM rating of 2,796 (59.2m³)
- Lightweight, only 32.5 lbs. (14.75kg)
- Stackable to save storage or work area space
- Powerful 1 hp electric moto (.75 kW)
- Capability to connect up to 125 feet (38m) of straight duct
- Ideal for confined spaces that require greater airflow
- UL & CUL listed

For confined spaces that require a powerhouse air ventilator, the UAF-3000 can handle your most demanding industrial needs.

With a forceful 1 hp motor, the UAF-3000 can deliver both positive and negative airflow at an incredible maximum capacity of 2,796 CFM in the most difficult work environments. No matter what your industry or application — construction, demolition, utility, paper mill, shipyard, power station, tank purging, or manufacturing — the UAF-3000 is designed to take on the toughest jobs.

VPN: A-3000

DIMENSIONS

MODEL	• 3000
Fan Type	Axial Blower/Extractor
Size	12" dia. (305mm)
Weight	32.5 lbs. (14.75kg)
Height	21" (533mm)
Length	17" (432mm)
Width	14" (355mm)

AIR FLOW RATES

MODEL: 3000	A	B		
	CFM	M ³ /Min.	CFM	M ³ /Min.
Free Air	2796	79.2	2492	70.6
15' straight	1938	54.9	1722	48.8
25' straight	1829	51.8	1646	46.6
40' straight	1764	50.0	1556	44.1
50' straight	1567	44.4	1173	33.2
75' straight	1254	35.5	1094	31.0
25' 1-90 bends	1564	44.3	1344	38.1
25' 2-90 bends	1377	39.0	1232	34.9



Pneumatic Ventilator

Features

- CFM rating of 2,063
- Lightweight, only 28 lbs.
- Stackable to save storage or work area space
- Powerful 1.5 hp electric motor
- Capability to connect up to 125 feet (38m) of straight duct
- Ideal for confined spaces that require greater airflow
- UL & CUL listed

For confined spaces that require a powerhouse air ventilator, the UAF-3000 can handle your most demanding industrial needs.

3000 can handle your most demanding industrial needs.

With a forceful 1.5 hp motor, the UAF-3000 can deliver both positive and negative airflow at an incredible maximum capacity of 2,063 CFM in the most difficult work environments. No matter what your industry or application construction, demolition, utility, paper mill, shipyard, power station, tank purging, or manufacturing — the UAF-3000 is designed to take on the toughest jobs.

Also Available! UAF-3000FRL

For hazardous space applications where air compressors or built-in air lines are the preferred choice of power, turn to the UAF-3000FRL.

With its built-in FRL Unit (Filter, Regulator, Lubricator), you will breathe easier and your UAF-300FRL will operate more efficiently.

VPN: A-3000P

DIMENSIONS

MODEL		• 3000P
Fan Type	Axial Blower/Extractor	
Size	12" dia. (305mm)	
Weight	28 lbs. (12.7kg)	
Height	21" (533mm)	
Length	17" (432mm)	
Width	14" (355mm)	

AIR FLOW RATES

MODEL	• 3000P	
	CFM	• M ³ /Min.
Free Air	2,063	58.4
15' straight	1,753	49.6
15' 1-90 bends	1,616	45.7
15' 2-90 bends	1,450	41.0
25' straight	1,619	45.8
25' 1-90 bends	1,497	42.4
25' 2-90 bends	1,433	40.6
50' straight	1,531	43.3
100' straight	1,243	35.2



High Capacity Ventilator

Features

- CFM rating of 9,968
- Weighs only 119 lbs. (53.97kg)
- Powerful 5 hp electric motor
- Two built-in handles
- Dual-wall shell design
- Ideal for larger areas that require greater airflow

Designed for use in areas that require a greater exchange of air, the UAF-8000 promises performance.

Equipped with a powerful 5 hp motor, the UAF-8000 generates both positive and negative airflow at an outstanding maximum capacity of 9,968 CFM. Hold onto your seat, this 20.5 inch unit outperforms ventilators three or four times its size. If you're in need of a ventilator for larger applications, turn to the one that provides extreme performance, turn to the UAF-8000.

VPN: VAF-8000

DIMENSIONS

MODEL		• 8000
Fan Type	Axial Blower/Extractor	
Size	20.5" dia. (520mm)	
Weight	119 lbs. (53.97kg)	
Height	27.5" (698mm)	
Length	27.5" (698mm)	
Width	25.5" (647mm)	

AIR FLOW RATES

MODEL:	8000 • A	
	CFM	• M ³ /Min
Free Air	9968	282.3
25' straight	9379	256.6
25' 1-90 bends	7193	203.7
25' 2-90 bends	6726	190.5
50' straight	8664	245.3
75' straight	8313	235.4



MASTER 8" Confined Space Ventilator

Features

- CFM rating of 930
- ETL Compliance
- Lightweight, only 15 lbs.
- Stackable for efficient storage and work space
- 8 motor mount vanes in separate poly sleeve
- Dual walled polyethylene housing design

MASTER® 8" Confined Space Ventilator with Attached Ducting/Canister all-in-one unit. The MASTER 8" ventilator is lightweight and has a small diameter, making it ideal for use where space is at a premium. It comes complete with 25' of ducting in an integrated duct carrier for greater convenience.

The ventilator and ducting/canister all-in-one unit can be purchased as a complete unit or as separate pieces. MASTER - The professional's choice since 1953. **VPN: M08-25**

Size:	8" dia.	Width:	12.5"	Cord Length:	12 feet
Weight:	35/30 lbs.	CFM (Free Air):	930	Drive Type:	Direct
Height:	14.5"	CFM Range (Free Air):	<1000	Fixed or Portable:	Portable
Length:	36.25"	Max Fan Diameter:	8"	Housing Color:	Yellow



Duct with Quick Connect

Available in 15- or 25-foot lengths for any model, our duct hoses are made of flexible, light-duty vinyl-woven polyester. Ducts are easily retractable and designed to handle large volumes of air at relatively low pressure. The ducts are flame-retardant and easily connect to fan lips for positive or negative airflow. Model 1225-SC duct is dipped in static-conductive material for safe use in hazardous environments.

8" diameter by 15' length	VPN: A-0815	8" diameter by 25' length	VPN: A-0825
12" diameter by 15' length	VPN: A-1215	12" diameter by 25' length	VPN: A-1225



8-inch Duct Coupler

This circular metal ring will allow you to connect multiple sections of duct.

VPN: A-8000



Duct Storage Rack

Durable metal rack can store two 15-foot lengths or one 25-foot length of 8-inch or 12-inch diameter duct.

8 inch	VPN: UTDSR-25-08	12 inch	VPN: UTDSR-25-12
--------	-------------------------	---------	-------------------------



Duct Carrier

These lightweight polyethylene duct carriers hold up to 25 ft. each of 8-inch or 12-inch flexible ducting.

8 inch	VPN: UTDSR-25-08P	12 inch	VPN: UTDSR-25-12P
--------	--------------------------	---------	--------------------------

Rubber Cable Protector

Features

- Heavy Duty Single Channel Protector For Cable And Hose Lines Up To 1" Diameter
- Non-Metallic, Industrial-Grade Rubber Construction
- Optional Connector Kit Available For Most Sizes
- Reduces Tripping Hazards
- Protects/Organizes Portable Cords & Cables

VPN: 55550



Plastic Cable Protector

Features

- Protects cables and hoses up to .75" outside dia.
- Reinforced hinged lid for easy cable placement with standard ramps
- Dog-Bone Connectors to extend to any desired length
- Patented 5-bar tread surface for maximum traction
- Modular interlocking design for easy setup

VPN: 55560

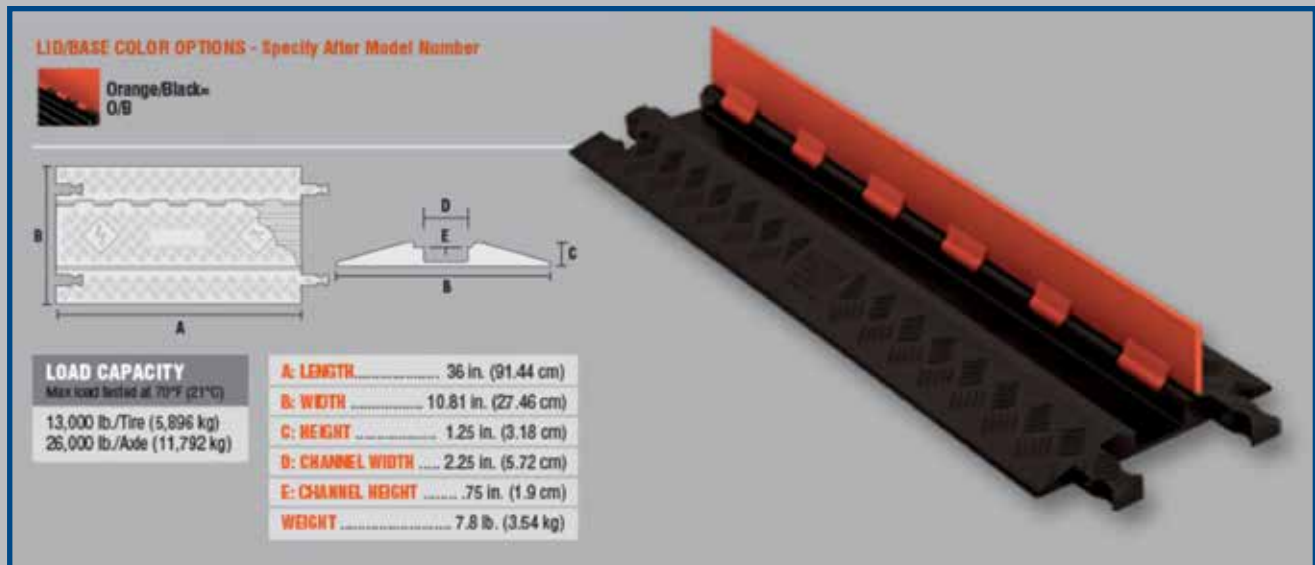



Micro-Trench Tamper Tool

Features

- 14" long, 3/4" wide tamping end
- Tamping end constructed from 100% recycled solid plastic
- Welded, forged steel handle attachment
- Designed for quick and easy use

The increase in fiber deployment initiatives have created the need for more cost effective ways of managing the task of fiber installation. Micro-trenching is one such solution.

Micro-trenches are low impact slot cuts into roads, sidewalks, etc, in which fiber is placed. This method offers quick and easy install, clean-up and surface repair, especially in urban areas. Although the widths and depths of these trenches vary based on local municipality specifications, the most common dimensions of the trenches are at least 1" wide, and up to 12" deep.

One challenge faced when placing fiber into these trenches is making sure the fiber is laying at the bottom of the entire trench in order to avoid potential future damage by road re-surfacing or other maintenance activities on the surface above. We've created a quick and easy tool that will ensure that your fiber is tucked neatly at the bottom of the trench and out of harms way.

The 3/4" thick, 14" long tamper fits easily into the slot-cut, and, with it's curved end design, fits snug to the fiber cable without pinching or cutting. The tamper end is made from 100% recycled plastics fitted over welded forged steel. The straight 48" hardwood handle makes it easy to use and quick to tuck away in the back of your truck.

VPN: 55400

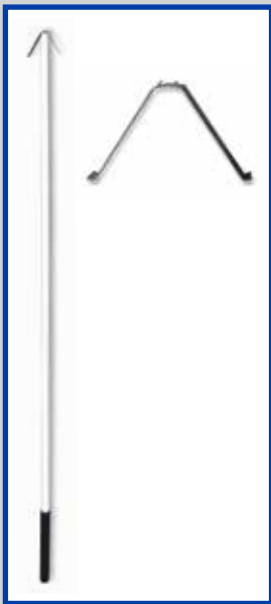
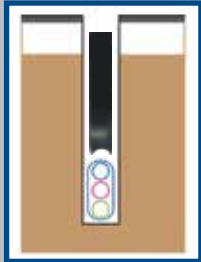

Micro-Trench Clip and Insertion Tool

Features

- Quick & easy insertion into narrow trenches
- Prevents microduct movement when backfilling
- Clips constructed from durable stainless steel

Micro-trenching has become a widely accepted method of installing fiber optic services into areas where traditional cable placement would be too invasive.

Micro-trenching involves cutting a narrow trench into concrete sidewalks, asphalt roadways, across parking lots, etc. Microduct is then installed into these trenches and usually placed relatively shallow as compared to traditional cable trenches.

Many times the ducts float inside the trench for a myriad of reasons, mostly from the memory of the plastics, or the direction the trench is taking.

U-TECK has developed an approved method of holding the duct firmly to the bottom of the trench by placing our new trench clips into the narrow gap of the trench and firmly against the duct.

These spring clips expand and press against the sidewalls of the trench and hold the duct in place so that backfilling procedures can then take place.

These clips are installed using our trench clip insertion tool.

A trench clip is attached to the tip of the trench clip insertion tool and then pressed into the gap of the trench and firmly against to the top of the duct.

Trench clips are specially designed to release from the insertion tool as they are forced into the gap. Trench clips are packaged in a standard package on 1000 pcs.



Product

Micro-Trench Clip Insertion Tool
Micro-Trench Clip

VPN

55300
55310

Packaging

1 each
1000/Box

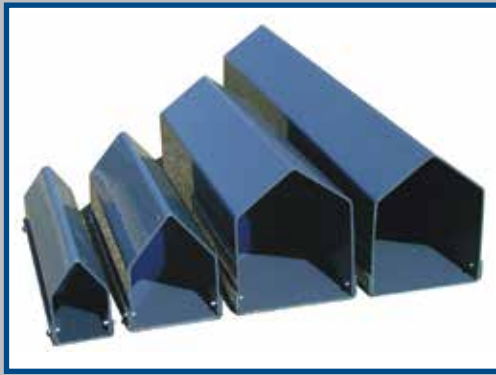

Buried Closure Protective Housing

Features

- Simple to install
- Durable
- Few piece parts
- Chemical-resistant
- High-impact plastic
- No special tools required
- Convenient
- Re-enterable
- Cost-effective
- Environmentally safe

U-TECK can provide you with a way to protect your pressurized closures from “ghost leaks” and your filled closures from damage.

Pressurized Closure: The Buried Closure Protective Housing, or Closure Coffin, is designed to protect your pressurized closure

from the weight of the backfill, as well as from the added weight of vehicles that run over the splice location, potentially causing costly ghost leaks.

All pressure crews are very familiar with this problem: The weight of the dirt and road vibrations can cause the closure to become disfigured around the end plate, causing a small leak to occur. When the dirt is removed the closure recovers and the leak goes away. This is why it is called a ghost leak. Also, if cables are not secured and protected where they entered a drilled plate, a ghost leak might occur. The Buried Closure Protective Housing can eliminate this.

Non-Pressurized: Even here, the closure can suffer damage from the weight of the dirt. We have come to realize that the re-enterable compounds do not provide the strength needed to withstand the weight. The Closure Coffin does. Also, in rocky areas, the sharp rocks can penetrate and deform many closures, allowing water to enter or causing damage from compression.

Before the development of the Buried Closure Protective Housing, companies were using creosote-covered boards or other treated lumber, which decays, and sand or split pipe, which requires an excessive amount of labor.

Ordering Information

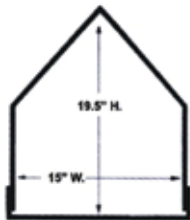

Product 57431 Series



Product 55431 Series



Product 53431 Series



Product 51431 Series

Product Lengths

AB 38" CD 51" EF 59" GH 68" IJ 76" KL 85"

Product #	WT/LBs	Product #	WT/LBs	Product #	WT/LBs	Product #	WT/LBs
57431 AB	49	55431 AB	40	53431 AB	34	51431 AB	28
57431 CD	66	55431 CD	54	53431 CD	45	51431 CD	37
57431 EF	76	55431 EF	62	53431 EF	52	51431 EF	43
57431 GH	88	55431 GH	72	53431 GH	60	51431 GH	50
57431 IJ	98	55431 IJ	80	53431 IJ	67	51431 IJ	55
57431 KL	110	55431 KL	89	53431 KL	75	51431 KL	62

Custom sizes are available upon request.

Note: For classification, the products will fit the type of closure in parenthesis: 57431 = (E0), 53431 = (C), 51431 = (A or B). For other closures, compare outside dimensions of the closure to inside dimensions of Buried Closure Protective Housing.

Test Results

Property	Unit	ASTM Test No.	Results
Tensile strength	PSI	D-638	7500
Elongation at yield	%	D-638	3.0
Modules of elasticity in tension	PSI	D-638	4.11×10^4
Flexural strength	PSI	D-790	12,800
Modules of elasticity in flexure	PSI	D-790	4.81×10^4
Impact izod	FT/LBs	D-256	8/1.5
Hardness rockwell "R"	R	D-785	115
Hardness shore "D"	D	D-2240	89
Compression strength	PSI	D-895	10,000
Sheer strength	PSI	D-732	7,550
Thermal conductivity	BTU/HR/FT ² /°F/IN		1.16
Water absorption		D-570	.12



SealGuard II Kit

Features

- Designed for high inflows in precast or brick-lined structures
- Stops leaks of up to 50 GPM
- Can be injected into flowing water with a reaction time of 3 seconds
- Dual-component polyurethane grout
- Permanent fix
- 45 PSI compressive strength
- Each set of grout contains one cubic foot of cured material that will not shrink

Repair Options

- Excavate and replace? – Very Expensive
- Reline with cements or elastomers? – Expensive, and the problem area must be dry
- Grout with cements? – Nothing more than a temporary patch
- Repair with chemical grouts? – Will wash out if the flow rate exceeds 1 to 2 GPM

None of these options will stop leaks of up to 50 GPM in seconds!

One manhole leaking 5 GPM will leak 7,200 gallons per day! If the cost of treating wastewater is \$1.70 per thousand gallons, then this single manhole with a 5 GPM leak costs \$4,467 per year. That is \$4,467 per year forever.

The savings in wastewater treatment fees in the first year for a single manhole with a minor leak is over \$4,000.



A SealGuard II Kit contains:

- Twelve sets of dual-component polyurethane grout
- Dual-component heavy-duty caulk gun
- Two pairs of chemical gloves
- Instruction sheet
- Convenient waterproof carrying case
- Twelve static mixers
- Safety goggles
- Safety clothing
- MSDS sheet
- Top-notch support from SealGuard technicians

SealGuard II stretches your repair dollars!

- Each component can be reordered separately
- Larger quantities available (full and half pallets)

SealGuard II requires only these tools:

- Hammer drill; 5/8" masonry bit; Hammer; Flat-tip screwdriver; Knife; Putty knife;
- Rags, oakum or burlap

SealGuard II cleans up easily!

- Snap mixers (15 minutes after injection) with a sharp downward motion.
- Use a putty knife to scrape excess material from concrete.
- Dispose of waste foam with ordinary wood or plastic waste.



Universal Ladder Wedge

Features

- Supports ladders with feet up to 6.5" wide
- Prevent Accidents
- Available in Safety Yellow and High Visibility Orange
- Positive Footing
- Extremely Rugged
- Anti-Skid
- Adjustable
- Metal or Rubber Cleats

Years ago, U-TECK combined a longtime, craft-accepted wooden ladder wedge design with polyethylene material to produce a rugged ladder wedge that can be warranted for up to five years. Using this material prevented paint scrapes and gouges by doing away with wood, and painting, all together; the color is molded throughout the polyethylene wedge. In reviewing this popular standard in ladder leveling, we found that the ladders most often used today by OSP personnel have transitioned to ladders with wider feet. Because of this research, we've increased the footprint size to each ladder wedge tier to accept up to 6-1/2" wide ladder feet. The "Universal" ladder wedge has all the same great features and load capacity as the original, but has now become much more versatile.

The Ladder Wedge is used when a ladder must be put against a building, cable, or pole, and one leg does not touch the ground firmly, thus creating an unsafe climbing condition. The Ladder Wedge is placed under the unlevel foot to make the ladder steady.

The U-TECK Ladder Wedge is also needed on soft ground to prevent earth movement, which can cause the ladder foot to move while the user is climbing.

The Ladder Wedge was put through rigorous testing by an outside testing facility. Their material analysis report concluded that no visible evidence of any deformation or failure of the wedge was noted at our specified 375 lb. minimum load or at their standard 396 lb. load test stop point.

Product

Yellow Ladder Wedge (Metal Cleats)
 Yellow Ladder Wedge (Rubber Cleats)
 Orange Ladder Wedge (Metal Cleats)
 Orange Ladder Wedge (Rubber Cleats)

VPN:

55429-P-M
 55429-P-R
 55429-POr-M
 55429-POr-R



Metal cleats should be used on grass, dirt, or asphalt surfaces.



Rubber feet should be used on wood floors, smooth concrete, or any slick surface.



Rung Runner Ladder Caddy

Features

- Can be used with any style of ladder
- Reduces worker fatigue
- Helps prevent back strains and injury
- Decreases property damage
- Increases single-worker productivity
- Fast and easy assembly with most ladders
- Worry-free tires easy to maintain
- Off-sets ladder weight for safer single-worker use

U-TECK introduces the Rung Runner™, the easiest way to carry and transport heavy extension ladders from vehicle to job site. Using a universal tether, you can now carry any type of ladder, including large extension ladders with solid rails.

The Rung Runner™ has a unique design that enables it to cradle any type of extension ladders on their side, reducing the ladder weight by as much as 90%. This is the easiest and most stable way to carry them.

Using the new Rung Runner™, worker fatigue is virtually eliminated, off-setting the weight of the ladder, making it lighter and more easily maneuverable into tight spots such as parking lots, construction sites, and into gated fences.

Worker productivity is increased because of the ease of getting ladders to and from the work site more quickly.

The framework is constructed of lightweight polymer and stainless steel, making U-TECK's Rung Runner™ extremely tough and durable.

VPN: 59501-C



Easy to use in four easy steps!

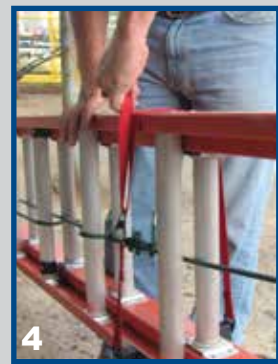

The Rung Runner™ attaches to any extension ladder using the universal tether as shown. There are no tools required. Also, by using our simple attaching method, there is nothing to permanently attach to the ladder.

Once at the work site, quickly press the quick release buckle on the universal tether and slide the tether off of the ladder and you are ready to work. Once your work has finished and your extension ladder is ready to transport, slip the Rung Runner™ universal tether onto the ladder, tighten the tether, and you are ready to effortlessly leave the job site.



Step Runner™ Step Ladder Caddy

Features

- Can be used with any style of step ladder
- Reduces worker fatigue
- Decreases property damage
- Increases single-worker productivity
- Fast and easy assembly
- Worry-free tires easy to maintain
- Off-sets ladder weight for safer single-worker use

U-TECK introduces the Step Runner™, the easiest way to carry and transport heavy step ladders from vehicle to job site. Using a universal tether, you can now carry any type of step ladder.

The Step Runner has a unique design that enables it to cradle any type of step ladders on their side, reducing the ladder weight by as much as 90%. This is the easiest and most stable way to carry them.

Using the new Step Runner, worker fatigue is virtually eliminated, off-setting the weight of the ladder, making it lighter and more easily maneuverable into tight spots such as gated fences.

Worker productivity is increased because of the ease of getting ladders to and from the work site more quickly, while being able to carry additional tools and equipment at the same time.

The framework is constructed of lightweight polymer and stainless steel, making U-TECK's Step Runner™ extremely tough and durable.

VPN: 59501-STP

WEIGHT: 14 lbs.



Pole Mounted Ladder Bracket

Features

- Provides Correct Ladder Positioning for Technicians
- Permanently Attaches to poles Under Cabinets
- Attachment Point for Safety Harness
- Powder Coated Steel and Stainless Hardware

U-TECK's Pole Mounted Ladder Brackets are used in conditions where Distribution Cabinets, UPS Cabinets and other equipment is mounted onto utility poles and where technicians are using ladders to access them. Too often the angle of the ladder is positioned under the cabinets creating an unsafe angle for the worker to stand, open the cabinet, and perform routine functions.

Our Pole Mounted Ladder Bracket puts an end to that unsafe condition. Our Brackets are permanently mounted under the cabinet and adjusted to the correct depth of the cabinet. Once installed, and the ladder deployed, the cabinet can be safely opened, and work performed, providing a safe and comfortable angle to work. These Brackets can be adjusted from 21" to 27" away from the pole using 2 stainless steel through bolts. Brackets are mounted to the pole using thru-bolts (not provided). Currently available in 3 colors.

Product	VPN	Weight
Pole Mounted Ladder Bracket - Almond	55900-001	40 lbs.
Pole Mounted Ladder Bracket - Green	55900-002	40 lbs.
Pole Mounted Ladder Bracket - Brown	55900-003	40 lbs.



Pack-Rat Locator's Vest

Features

- Specifically designed for Utility Locators
- Carry up to 4 marker paint cans and 200 marking flags
- Pocket locations ensure comfortable and balanced carrying capacity
- Available in fluorescent orange-red or fluorescent yellow-green
- ANSI/ISEA 107-2004 Class 2 compliant
- U.S. Patent: US D622036 S

Cans of paint. Marker flags. These are just some of the tools of your trade. Where do you put them while walking city streets or through rural neighborhoods with your locator & paint sprayer in hand, and when your work van can be blocks away? Only one vest can take on the load, and that is the U-TECK Pack-Rat™ Locator Vest!

Originally created with locating personnel in mind, the U-TECK Pack-Rat™ Locator Vest reduces job completion time by providing specially designed pockets and pouches for a comfortable and balanced way of carrying up to 4 spray-paint cans, over 200 marking flags, inductive clamp, test leads, can wrench, pliers, radio/cell phone, dog repellent, maps, pens, etc. Everything

you need is all within reach, while the vest maintains the ANSI/ISEA 107-2004 Class 2 rating required for federal roadways.

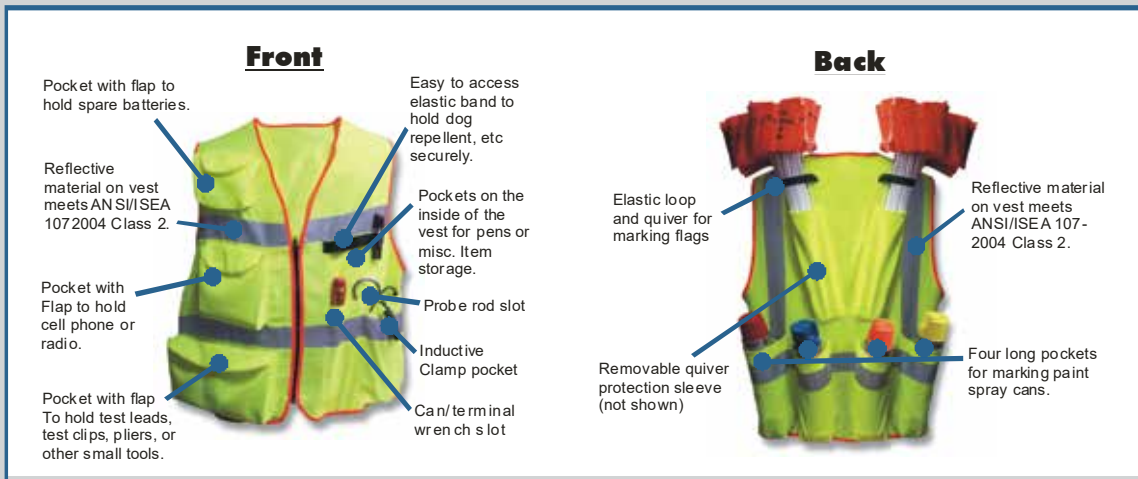

Pack-Rat Ordering information:



Class 2 Original
ANSI/ISEA 107-2004 Class 2 rated, 100% Polyester.

Item	VPN
Orange vest	60001
Yellow vest	60002Y

Sizes Available: L, XL, XXL, XXXL



Class 2 Mesh
ANSI/ISEA 107-2004 Class 2 rated, 100% Polyester Mesh.

Item	VPN
Orange vest	60021
Yellow vest	60022Y

Sizes Available: L, XL, XXL, and XXXL



Class 2 Original
ANSI/ISEA 107-2004 Class 2 rated, 100% Polyester.

Item	VPN
Orange vest	60001
Yellow vest	60002Y

Sizes Available: L, XL, XXL, XXXL





Five Pocket Tool Pouch

Tool Pouches

Features

- Constructed of 1000d Cordura
- Flexible / Comfortable / Water-resistant for maximum durability
- Snaps securely to your belt
- Cut and puncture resistant Coverlite lining
- Holds tools firmly
- Made in America

Keeping your tools comfortably and securely within reach.

Tough inside and out, both the 5-Pocket and 6-Pocket Tool Pouches are constructed of wear-resistant Cordura with a special water, cut and puncture resistant Coverlite lining and attach securely to your belt with heavy-duty snaps.

Designed specifically with your comfort in mind, wearing these lightweight pouches does not inhibit bending or flexing, unlike other stiff and cumbersome types of materials. Our tool pouches get the job done, increase your productivity, and offer years of use.

These multi-pocket pouches conveniently hold your tools of the trade:

- Voltage detector
- Terminal wrench
- Extra pocket for your screwdriver
- Splicer snips
- Skinning knife
- Other small tools

Product

Five Pocket Tool Pouch
Six Pocket Tool Pouch

VPN

39401-5
39401-6



Six Pocket Tool Pouch

Cable and Wire Storage Box

Features

- Two cable guides for easy payout
- Constructed from rustproof high density structural plastic
- Keeps contents dry in harsh conditions
- Measures 37" wide x 21" deep x 20" high
- Recessed soft grip handles
- Theft resistant key lock with 2 keys
- For added security, two padlocks can be added

U-TECK has come up with a practical solution to the problem of storing and transporting drop wire, station wire, and aerial drop wire shipping boxes.

Usually, these shipping boxes are out in the weather, getting wet, and disintegrating, making it more difficult to use them as they were intended. Also, theft of copper wire has become an ever increasing problem.

U-TECK has developed a Cable and Wire Storage Box that fits neatly in the back of service trucks and vans, keeping these boxes of wire and cable dry, safe and secure.

Additionally, there are two cable guides on the front of the storage box so cable can be pulled from the innerboxes without having to unlock it. Each box is made from tough, high density, structural plastic, which will withstand the harshest elements.

With a soft-feel, recessed handle on each end and a keyed lock your cable, wire, and other contents are going to remain safe and ready when you need them.

VPN: 59100



Reel-Deal™ Cable Caddy

Features

- Constructed from 3/4" impact resistant plastic
- High visibility safety yellow
- Quick release spindle construction for easy reel loading on either side
- Pivoting, rubber feet and wide base prevents sliding or tipping
- Compact design perfect for storage and transport
- Made in America

Storing, transporting and using your cable reels on site is no longer a multi-step process. With the new U-TECK Reel-Deal Cable Caddy, you can do all of this with one simple tool.

Made from solid 3/4" impact resistant plastic, the Reel-Deal can handle the everyday wear and tear all of your equipment is subjected to, and then some. The non-fading safety yellow color gives you extra visibility. Notched handle makes for easy pick-up and go!

Most reel caddy's have wheels or simple, easy to tip steel framing. The most import feature that makes the Reel-Deal stand out from the rest is the stout, compact design and pivoting rubber feet that allows on-the-spot security with no slipping, no tipping, even on unlevel terrain. Holds reels with a combined weight of up to 200 lbs!.

Other unique features include the quick-release spindle construction for easy reel loading from either side, and the reel divider that allows each reel to move independently from the others. This allows you to pull cable from more than one reel - in opposite directions, at the same time!

Whether you do work for telecoms or CATV's, the Reel-Deal Cable Caddy is ready to go to work for you.

Size: Size: 21-1/4" L x 16" W x 19-3/4" H Weight: 11lbs

VPN: 59000



Reel-Deal™ Single Pull Line Caddy

Features

- Constructed from 3/4" impact resistant plastic
- High visibility safety yellow
- Quick release spindle construction for easy reel loading
- Pivoting, rubber feet and wide base prevents sliding or tipping
- Compact design perfect for storage and transport
- Made in America

Pull tape & pull line products are used to help expedite cable installation. Also, pull tapes are often used once and discarded. But with U-TECK's Reel-Deal , you can now easily reel out the pull line then re-spool it, allowing you to re-use it again and again. Storing, transporting and using your pull line on site just got easier and more efficient. With the new U-TECK Reel-Deal Single Pull Line Caddy, you can do all of this with one simple tool.

Made from solid 3/4" impact resistant plastic, the Reel-Deal can handle the everyday wear and tear all of your equipment is subjected to, and then some. The non-fading safety yellow color gives you extra visibility. A notched handle makes for easy pick-up and go!

Most reel caddy's have wheels or lightweight, easy to tip steel framing. Of all the features offered by the Reel-Deal, the most important is the stout, compact design and pivoting rubber feet that allows on-the-spot security with no slipping, no tipping, even on unlevel terrain. Another unique feature includes the quick-release spindle construction for easy pull line loading. The Reel-Deal holds reels of up to 200 lbs!.

Whether you do work for telecoms or CATV's, the Reel-Deal Single Pull Line Caddy is ready to go to work for you.

Size: 14-1/2" L x 18" W x 23" H Weight: 11lbs

VPN: 59011



Work Umbrella

Features

- Heavy-duty construction
- 3-position tilt optional
- Aluminum/hardwood poles
- Reinforced vinyl canopy
- Optional carrying case
- Pointed poles for easy set-up

U-TECK's line of umbrellas provides an economical method of protection from the elements, rain or shine. Unique tilt-top feature allows user to shade themselves from ultraviolet sun rays any hour of the day.

Strong enough yet light enough to be used on mowers, tractors, etc.

For safety purposes, our umbrellas have a hardwood extension pole so no metal-to-metal contact with underground utilities can be made.

Our carrying bags are also unique in that each one has a separate pocket for the umbrella extension. This eliminates damage due to improper insertion of the umbrella.

We also offer two additional accessories as options for securing your work umbrella, the suction mount and the adjustable tripod stand. Both give you more freedom when placing your umbrella on the job, whether you are working next to cabinets or on hard surfaces.

Product
 5½' Non-tilt umbrella
 7' Non-tilt umbrella
 6' Tilt umbrella

VPN
73005
73007
73006-T

Product
 6' Non-tilt umbrella
 5½' Tilt umbrella
 7' Tilt umbrella

VPN
73006
73005-T
73007-T



Dielectric Umbrella

Features

- High-visibility, heavy duty yellow umbrella with top air vents
- Fiberglass extension pole and skeleton
- Comes complete with adjustable tripod
- Offered with straight pole or with our exclusive Sturdy-Tilt locking hinge

U-TECK's line of dielectrically safe fiberglass umbrellas provides a variety of options for protection from the elements, rain or shine.

Our exclusive Sturdy-Tilt option with locking hinge allows the user to adjust the angle of cover for shade from damaging ultraviolet rays or from driving rain. We've also moved the tilt higher up the pole, to off-set the weight, making the umbrella more sturdy.

The optional window in the covering of the umbrella incorporates a piece of transparent plastic, which allows the worker to see obstacles or hazards that may be above the umbrella.

Each umbrella is constructed of materials that make it durable enough for use in high winds or harsh weather yet light enough to be used on mowers, tractors, etc.

For safety, our umbrellas have a hardened fiberglass composite extension pole so that no metal-to-metal contact can be made. The Dielectric Umbrella comes standard with an adjustable tripod stand with three anchor stakes. Carrying bags for handling or storage are also available.

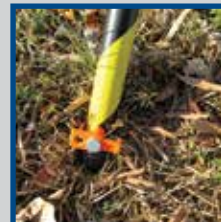



Suction Mount

Heavy Duty Suction Mount has secure pole fixture and clips that tighten to produce suction, then flip open to release suction. Lightweight yet strong ABS construction. Cups have 4 1/2in. diameter, total dimensions 12 1/2in. x 11in.

VPN: 730MNT



Adjustable Tripod Stand

Tripod stand with three anchor stakes

VPN: 730TRI



Carrying Bag

Black ballistic nylon with carrying handles and velcro flaps

Product
Dielectric Umbrella Carrying Bag
Work Umbrella Carrying Bag

VPN
7307BAG
73007-B



Attic-Trax Walk Boards

Features

- 700 lb. load rating
- Made from lightweight composites
- Two 18" x 26" textured, non-slip work surfaces per kit
- High-visibility yellow edges for visual safety
- Quick-connect comfort handle for easy transport
- Works in attics with 16" or 24" OC joist spaces
- Service temperature range: -40OF to 188OF

Attic-Trax™ Walkboards are used to assist a technician in traversing safely through an attic space while performing functions such as wiring, equipment installations, structural repairs, etc. Used in pairs, the Attic-Trax™ Walkboards are designed to provide ample standing surfaces while being

safely secured in place between either 16"OC (on center) or 24"OC joist spacing's.

Constructed from durable composites that has beveled edges and corners, the Attic-Trax™ Walkboards features four sturdy support rails underneath to prevent any movement once it has been put between the joists. A finger placement hole located in the center of each board allows for easy pick-up and placement.

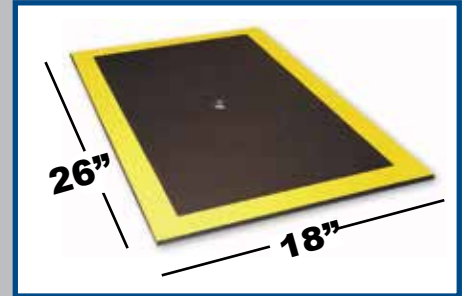

A convenient carry handle, able to be quickly attached or detached, connects a pair of Attic-Trax™ together for easy transport from truck to top of ladder. This carry handle is removed while Attic-Trax™ are in use and can easily fit into a pocket. Each Attic-Trax™ Walkboard is rated to carry a working load of 700 lbs. (318 kg).

VPN: 62028



Hardwood Wheel Chocks

Features

- Maple hardwood construction
- All galvanized metal handle, nuts, and bolts
- Galvanized 4 diamond, serrated surf, steel tread
- Steel loop carrying handle
- Fits most chock storage compartments
- Either side of wheel chock can be positioned against the tire

U-TECK's Hardwood Wheel Chocks are made from several pieces of maple wood joined together under high pressure with waterproof glue. They are painted safety yellow with rugged, all-weather paint, sealing it from dirt, grime, and water. The galvanized hardware and handle offers long-life wear that is rust-resistant. Wheel Chocks with Steel tread offer rugged, no-skid durability with it's galvanized, 4 diamond serrated surface.

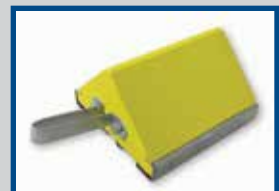

Description

Hardwood Wheel Chock with metal handle
10" Length x 9.25" Width x 5.25" Height

VPN
63001

Hardwood Wheel Chock with Steel Tread and metal handle
10" Length x 9.5" Width x 6" Height

63002

Safe-T Lid Temporary Covers



Features

- Available for use with Manholes or Handholes
- Made from high impact resistant polyethylene
- Environmentally stabilized to resist fading
- Lightweight and easily stored
- Custom sizes available

Designed with complete safety in mind, U-TECK's Safe-T Lid Temporary Covers provide fall-in protection while you perform various functions with a manhole or handhole lid removed.

Our Safe-T Lids are lightweight, yet very strong. Constructed from environmentally stabilized, high impact resistant polyethylene, it is strong enough to support over 400 lbs. of direct weight.

Featured on both the manhole and handhole temporary covers are openings along the edge large enough to accommodate cables that extend out of the hole, and two hand openings for easy transport, placement and removal.

Often splicing crews working inside splicing trailers beside a manhole need to provide additional fall-in protection from the public as well as the crew members themselves. Additionally, both types of Safe-T Lids Covers are also a great accessory for Utility Locators, who often must connect their equipment to the cables located in an existing man or hand hole while often leaving it unattended and unprotected.

The Safe-T Lid Temporary Cover for manholes can also be ordered with a transmitter hook. This allows the transmitter to be placed under the Safe-T Lid, reducing the possibility of damage or theft when the locator isn't looking.

We offer a choice of three sizes of Safe-T Lid Temporary Covers to fit the following manhole size: 24", 28", 32", 36", and 38". The Safe-T Lid Temporary Covers for Handholes are available to fit the two most common handhole sizes: 24" x 36" and 30" x 48".

Don't see a size to meet your requirement? Contact our Customer Service department to get a custom quote!



Ordering Information



Description	VPN
24" diameter manhole cover	28024-Y
28" diameter manhole cover	28028-Y
32" diameter manhole cover	28030-Y
36" diameter manhole cover	28036C-Y
38" diameter manhole cover	28038C-Y



Description	VPN
24" x 36" handhole cover	282436-Y
30" x 48" handhole cover	282448-Y



VERSA LID TEMPORARY COVER

U-TECK has developed a new product in the Safe-T Lid line. The VERSA LID allows you to have multiple sized lids all in one compact lid, saving storage space. The VERSA LID only weighs 36 lbs. and is 40" diameter. It will fit any opening from 27.5" to 38.5", and has 2 carry handles and 2 finger openings to allow for easy positioning and removal.

The VERSA LID can also be personalized with a company logo or graphic of your choice.

Description
VERSA LID

VPN
28038-VLC

Weight
36.2 lbs.

Camlock Levers

Fishtails

Graphics

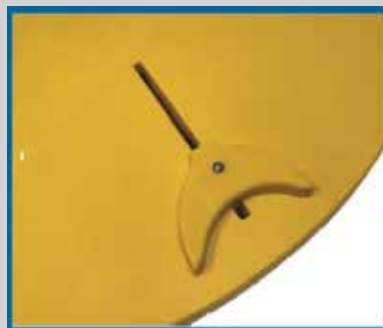

Chain Hoist



Features

- Simple design makes routine inspection and maintenance easy
- Steel construction with a rugged one-piece cast handle
- Freewheeling feature without load makes for quick load attachment
- Safety hooks swivel 360 degrees for easy rigging
- Induction hardened grade 80 load chain

This hoist is economical and designed for years of trouble-free use, with pulling applications ranging from 3/4 ton to 3 ton capacity. The lift ranges available are: 5' and 10' lift lengths.

This hoist is easy-to-use with it's one-piece cast handle and includes a completely enclosed Weston type automatic brake system for precise load spotting. The chain is heat treated and hardened grade 80 load. The simple design makes routine inspection and maintenance easy and a freewheeling feature without load makes for quick load attachment. The permanently lubricated gears and drop forged, swivel 360 degree, safety hooks make for easier rigging. Complies with OSHA standards and is ISO 9001 certified.

Description

Chain Hoist 3/4 ton w/5ft lift and 11in lever
 Chain Hoist 3/4 ton w/10ft lift and 11in lever
 Chain Hoist 1 1/2 ton w/5ft lift and 17in lever
 Chain Hoist 1 1/2 ton w/10ft lift and 17in lever
 Chain Hoist 3 ton w/5ft lift and 17in lever
 Chain Hoist 3 ton w/10ft lift and 17in lever

VPN

U187707
 U187708
 U187711
 U187712
 U187715
 U187716



Handi-Hoist Battery Lift

Features

- Attaches to any Wood, Composite, or Concrete Utility Poles
- Dual Safety straps are quick and easy to lock down
- Universal Rubber Pole Brackets
- Payload cannot free fall
- Rated lifting capacity of 175 lbs.
- Height lifting capacity of 30 feet
- Folds for easy transport and storage

The Handi-Hoist™ was designed to assist field technicians in the routine task of removing and replacing heavy USP batteries that are often located in aerial cabinets. Traditionally this job was performed by dangerously overloading the lifting capacity of bucket trucks or were simply carried up and down ladders. Most aerial lifts or bucket trucks have a lifting capacity of just 350 lbs. When you add an average worker and a set of tools, there's not much left for heavy items. Both methods are very unsafe and often the result could be personal injury or property damage.

U-TECK introduces the Handi-Hoist™, the easiest way to remove and replace heavy USP batteries from aerial cabinets. The Handi-Hoist™ was designed to assist field technicians in the routine task of removing and replacing heavy USP batteries that are often located in aerial cabinets. Traditionally this job was performed by dangerously overloading the lifting capacity of bucket trucks or were simply carried up and down ladders. Most aerial lifts or bucket trucks have a lifting capacity of just 300 lbs.

When you add an average worker and a set of tools, there's not much left for heavy items. Both methods are very unsafe and often the result could be personal injury or property damage.

The Handi-Hoist™ is also very useful when installing Small Cell, or DAS Sites, installing Video Cameras, Traffic Cameras, Emergency Warning Sirens, Aerial Cabinets, etc.

Ordering Information	Description	Product Number	Dimensions	Weight
	Handi-Hoist	55810	26.5" L x 13.75" W x 12.5" H	26.5 lbs.

Handi-Hoist Easy Step-by-Step Installation

1. Position Handi-Hoist at the desired location on the pole and strap it securely using the 2 quick cinch safety straps.
2. Lower Cable to the ground using a cordless drill with 5/8" socket adapter. (included)
3. Attach battery sling to the carabiner clip on the end of the hoist cable.
4. Using cordless drill in the forward direction, press the drill trigger to raise payload to the desired position.

Step 1



Step 2



Step 3





Ped-Mat

Features

- Fire-retardant
- Easy to install
- Cost-effective
- No herbicides No runoff
- Long lasting - 15 year warranty
- Improved visibility, reduces damage
- Discourages fire ants

Many years ago, U-TECK was approached by a major Regional Bell Operating Company (RBOC) to address their need for a herbicide-free alternative to control unwanted vegetation around pedestals. The solution is now known as WeedEnder®. Comprised of a dense, multi-directional needling of specially formulated synthetic polyester fibers, the material is additionally impregnated with a special resin with ultraviolet inhibitors and fire-resistant properties. Constructed from 100% recycled material, WeedEnder increases visibility, decreases herbicide use and site maintenance, and proves to be extremely durable.

Not to be confused with landscape fabrics, the ¼ inch matting is rugged and strong, held in place with a specially designed 316 stainless steel staking system and an adhesive/caulking formulation, created especially for use with the WeedEnder material, that can be used in wet or dry conditions. But as tough as it is, WeedEnder offers unusual versatility by allowing it to be rolled up in the event of line repairs or additions then rolled back into position without any decrease in performance.

While Ped-Mat dramatically reduces damage from Bush-Hogs and other heavy equipment by increasing visibility around your pedestals, it is also great for public relations by eliminating unsightly overgrown grass around pedestals or other fixtures on or next to someone's manicured lawn. You get all of these benefits without the burden of weed-eating or unsightly herbicide use.

Specifications

Ped-Mat 1 is die-cut to fit around a round pedestal with a 6", 8", 10", 12", or 14" diameter.

Ped-Mat 2 is die-cut to fit around a square or rectangular pedestal with the following dimensions: 6 5/8" square, 12 7/8" square, or 10 ½" x 23."

Ped-Mat 3 is not die-cut and fits in those hard-to-fit areas, such as next to poles, other pedestals, or other obstructions. You cut it to the size and shape needed.

** Note: Each Ped-Mat measures 3' x 4' and comes with heavy-duty, corrosion-resistant 316 stainless steel stakes.

** Note: Other sizes and configurations are available upon request.

Joining Strip is a 4" x 25' strip to join the WeedEnder rolls.

316 Stainless Steel Stakes are 6" long and are designed to hold the mat in place. The top hooks over and into the mat, while the bottom hooks under to keep the stake from pulling out of the ground. 316 stainless steel construction keeps rust at bay for longer life.

316 Stainless Steel Staples measure 1 1/4" x 5/8" and are packed 2,000 per box. These are used to join two widths of WeedEnder material with the joining strip.

Manual Staple Gun holds 150 stainless steel staples and is specially designed for use with our staples and the WeedEnder material. Pre-set depth allows staple penetration through the material for splices and repairs.

Adhesive/Caulk is specially formulated for primerless adhesion to the WeedEnder material and the metal or wooden guardrail posts (in wet or dry conditions) to inhibit weed growth.

Ordering Information

Description	Color	VPN	Quantity	Weight	Pricing Unit
Ped-Mat 1	Green	74001-G	10	37 lbs	1
Ped-Mat 2	Green	74002-G	10	37 lbs	1
Ped-Mat 3	Green	74003-G	10	37 lbs	1
Joining Strip	Green	74403-G	1	2.5 lbs	1
316 SS Stakes	N/A	74000	100	7 lbs	Box
316 SS Staples	N/A	74100	2,000	3.8 lbs	Box
Manual Staple Gun	N/A	74200	1	4.4 lbs	1
Adhesive/Caulk (tube)	Green	8ADHESIVE-W	12	10 lbs	Case

Note: All configurations of the Ped-Mat are also available in asphalt-color (black).



Ped-Mat 1



Ped-Mat 2



Ped-Mat 3

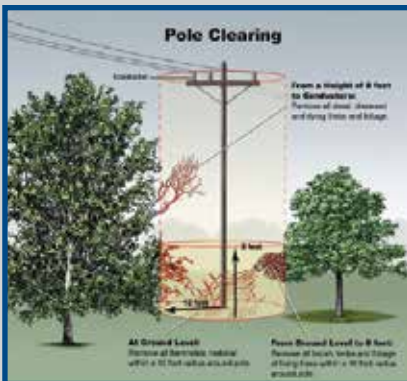

Utility Pole Mat Kit

Features

- Fire-Retardant
- 15 Year Warranty
- No Herbicides
- Prevents Vegetation Growth
- Easy to Maintain
- Easily Cut To Fit Any Area

Maintenance crew members have thousands of miles of utility lines to cover in order to maintain all non-exempt equipment. For example, one utility company states that maintenance crews are responsible for inspecting and removing flammable material within a 10 foot radius around approximately 120,000 poles and transmission structures in State Responsibility Areas. These numbers

continue to increase every year as more and more people move to rural areas and new power lines are added to support new communities. That's a lot of ground to cover!

So, how do you handle the ground level vegetation? Herbicides? Lawn mowers? Weed-whackers? Raking? All of the above? There is an easier way! We've created the WeedEnder Utility Pole Mat, a fire-retardant mat that provides vegetation control within a 12' radius around the pole. A mat so strong and durable that it carries a 15 year warranty!

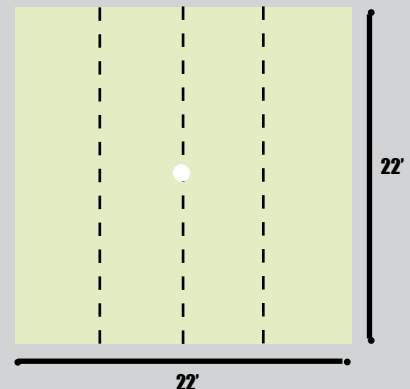

Product

Utility Pole Kit
(includes 70 hook stakes,
1 joining strip, and 2 adhesive tubes)

VPN

76022K-G

VESTS

Class 2



1514 & 1515



1513 Lime
1514 Orange

Premium
Black Series

Heavy Duty Vest

PERFORMANCE FEATURES

- Ultra-Cool™ 100% polyester mesh.
- Zipper front closure with durable webbing reinforcement.
- 2" wide high performance reflective material with 3" breathable contrasting color.
- Reflective trim around arms and piping down sides for added low light visibility.
- Black sides provide contrast and add a sporty look.
- Left and right chest mic tabs.

POCKETS

- Two lower outside cargo pockets with adjustable flaps and grommets.
- Right chest 2-tier pencil pocket.
- Left chest heavy duty gusseted radio/utility pocket with reflective piping.
- Two inside patch pockets.

SIZES: M-5X

(Size medium does not have black zipper or trim around neck and bottom - Will match garment color)

ANSI/ISEA 107 Class 2 Compliant

Everything you need to get the job done.

Left and right chest mic tabs for quick access.

Inside: Durable webbing reinforcements for rugged wear and tear.

Heavy duty expandable cargo pockets keep work gear in place.

Breathable contrasting trim reduces hot spots.

Gusseted radio/utility pocket with reflective piping.

Reflective trim & piping for added visibility.

Inside: Heavy duty tablet (iPad) pocket with load bearing strap.

1515 Lime
1516 Orange



Premium
Black Series®

Black Bottom Vest

PERFORMANCE FEATURES

- Ultra-Cool™ 100% polyester mesh with heavy duty black bottom and trim to keep vest appearance clean & professional.
- Zipper front closure with durable webbing reinforcement.
- 2" wide high performance reflective laminated material with 3" breathable contrasting color.
- Reflective trim around arms & piping down sides for added low light visibility.
- Left and right chest mic tabs.

POCKETS

- Two lower outside heavy duty expandable cargo pockets with adjustable flaps and grommets.
- Right chest 2-tier 4-division pencil pocket.
- Left chest heavy duty gusseted radio/utility pocket with reflective piping.
- Inside lower left heavy duty tablet (iPad) pocket with load-bearing strap.
- Inside lower right patch pocket.

SIZES: M-5X

ANSI/ISEA 107 Class 2 Compliant

VESTS

Class 2



1510 Lime
1511 Orange

Premium Brilliant Series®

Heavy Duty Vest

PERFORMANCE FEATURES

- Ultra-Cool™ 100% polyester mesh.
- Brilliant Trim reflective edging improves low light visibility.
- Zipper front closure with durable webbing reinforcement.
- 2" wide CNSS reflective material with 3" breathable contrasting color.
- Left and right chest mic tabs.

POCKETS

- Two lower outside cargo pockets with grommets and adjustable flaps.
- Right chest 2-tier pencil pocket.
- Left chest radio pocket with flap.
- Two inside patch pockets.

SIZES: M-5X

ANSI/ISEA 107 Class 2 Compliant

ML KISHIGO



1163 Lime
1164 Orange

Solid Front with Mesh Back Vest

PERFORMANCE FEATURES

- Comfortable Ultra-Cool™ 100% polyester mesh material on back with solid front.
- Zipper front closure.
- 2" wide CNSS reflective material with 3" contrasting color.
- Left and right chest mic tabs.

POCKETS

- Two lower outside patch pockets with flaps.
- Right chest 2-tier, 4-division pocket.
- Left chest radio pocket with flap.
- Two lower inside patch pockets.

SIZES: M-5X

ANSI/ISEA 107 Class 2 Compliant



1195 Lime
1196 Orange

All Mesh Contrast Vest

PERFORMANCE FEATURES

- Ultra-Cool™ 100% polyester mesh.
- Zipper front closure.
- 2" wide CNSS reflective material with 3" breathable contrasting color.
- Left and right chest mic tabs.

POCKETS

- Two lower outside patch pockets with flaps.
- Right chest 2-tier pencil pocket.
- Left chest radio pocket with flap.
- Two inside patch pockets.

SIZES: M-5X

ANSI/ISEA 107 Class 2 Compliant



We're listening and delivering.

Our inspiration and innovation come from one thing—you. The best ideas for our ever-evolving product line come from the people who wear them. We're always interested in hearing what would make our products even better and use that feedback to design and manufacture work wear that makes your job easier.

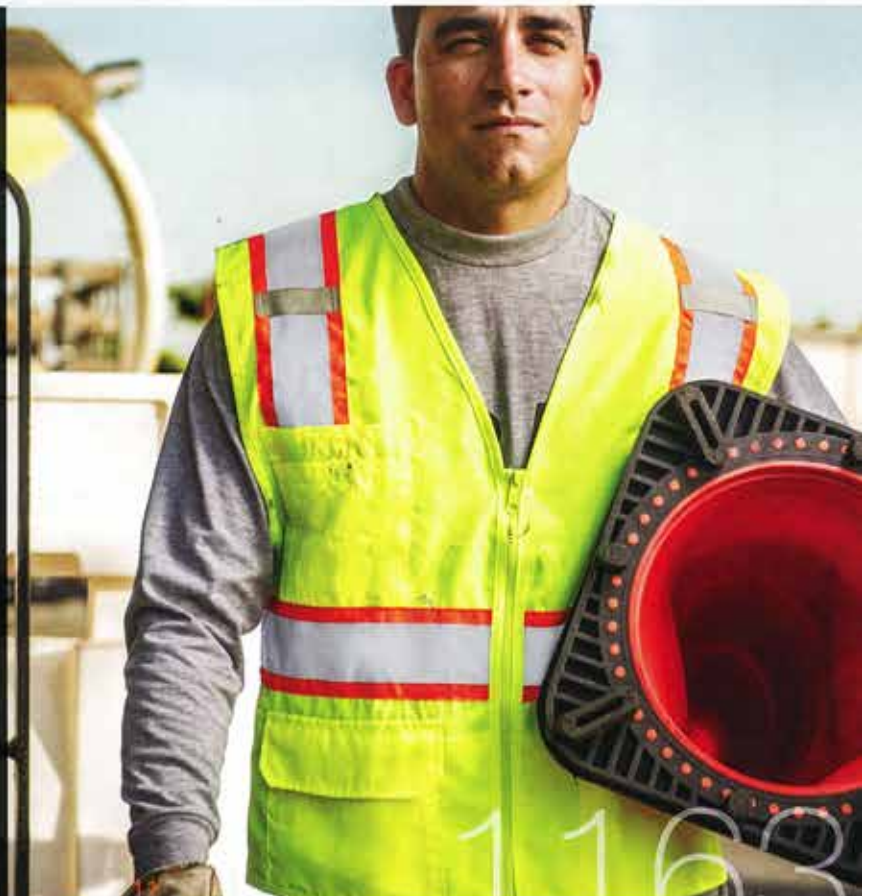

1163

VESTS

Class 2



1507 Lime
1508 Orange

Economy
Brilliant Series®

3 Pocket Zipper Mesh Vest

PERFORMANCE FEATURES

- Ultra-Cool™ 100% polyester mesh.
- Brilliant Trim reflective edging improves low light visibility.
- 2" wide reflective material.
- Left chest mic tab.

POCKETS

- Left chest radio pocket.
- Inside lower left patch pocket.
- Inside right chest 2-tier, 4-division pencil pocket.

SIZES: M-5X

ANSI/ISEA 107 Class 2 Compliant



1056 Lime
1055 Orange

Contrasting Mesh Vest

PERFORMANCE FEATURES

- Ultra-Cool™ 100% polyester mesh.
- Zipper front closure.
- 2" wide CNSS reflective material with 4.5" contrasting color.
- Left chest mic tab.

POCKETS

- Inside left chest 2-tier, 4-division pencil pocket.
- Lower right inside patch pocket.

SIZES: M-5X

ANSI/ISEA 107 Class 2 Compliant



1166 Lime
1167 Orange

4 Season Adjustable Mesh Vest

PERFORMANCE FEATURES

- Ultra-Cool™ 100% polyester mesh.
- Hook & loop front closure.
- 4-season adjustability allows for accurate sizing in any weather even over bulky coats.
- Two 1" wide CNSS reflective strips with 4.5" contrasting color.
- Left chest mic tab.

POCKETS

- Outside left chest 2-tier pencil pocket.
- Inside right chest 2-tier pencil/cell pocket.
- Two inside lower patch pockets.

SIZES: M-XL, 2X-4X

ANSI/ISEA 107 Class 2 Compliant





1085 Lime
1086 Orange

3 Pocket Zipper Mesh Vest

PERFORMANCE FEATURES

- Ultra-Cool™ 100% polyester mesh.
- Zipper front closure.
- 2" wide CNSS reflective material.
- Left chest mic tab.

POCKETS

- Outside left chest radio pocket with hook & loop tab.
- Inside right chest 2-tier, 4-division pencil pocket.
- Lower inside left patch pocket.

SIZES: M-5X

ANSI/ISEA 107 Class 2 Compliant



1083 Lime
1084 Orange

4 Pocket Hook & Loop Mesh Vest

PERFORMANCE FEATURES

- Ultra-Cool™ 100% polyester mesh.
- 4" hook & loop front closure.
- 2" wide CNSS reflective material.
- Left chest mic tab.

POCKETS

- Outside right chest 2-tier pencil pocket.
- Outside left chest patch pocket.
- Two large lower inside patch pockets.

SIZES: M-5X

ANSI/ISEA 107 Class 2 Compliant



1089 Lime
1090 Orange

Single Pocket Zipper Mesh Vest

PERFORMANCE FEATURES

- Ultra-Cool™ 100% polyester mesh.
- Zipper front closure.
- 2" wide CNSS reflective material.
- Left chest mic tab.

POCKETS

- Outside left chest pocket.

SIZES: M-5X

ANSI/ISEA 107 Class 2 Compliant



1291 Lime
1292 Orange

6 Pocket Zipper Solid Vest

PERFORMANCE FEATURES

- Lightweight 100% polyester solid material.
- Zipper front closure.
- 2" wide CNSS reflective material.
- Left chest mic tab.

POCKETS

- Two lower outside patch pockets with flap.
- Left chest radio pocket.
- Right chest 4-division pencil pocket.
- Two inside patch pockets.

SIZES: S-M, L-XL, 2X-3X, 4X-5X

ANSI/ISEA 107 Class 2 Compliant

VESTS

Class 2



1517 Lime
1518 Orange

4 Pocket Contrast Mesh Vest – Economy

PERFORMANCE FEATURES

- 100% polyester mesh.
- Zipper front closure.
- 2" wide reflective material with 3" solid contrasting color.
- Left chest mic tab.

POCKETS

- Two lower outside patch pockets with flaps.
- Right chest 2-division pocket.
- Left chest radio pocket with hook & loop tab closure.

SIZES: S-M, L-XL, 2X-3X, 4X-5X

ANSI/ISEA 107 Class 2 Compliant



1191 Lime
1192 Orange

6 Pocket Mesh Vest – Economy

PERFORMANCE FEATURES

- 100% polyester mesh material with solid polyester pockets.
- Zipper front closure.
- 2" wide reflective material.
- Left chest mic tab.

POCKETS

- Two lower outside patch pockets with flaps.
- Right chest 2-division pocket.
- Left chest 4-division pocket.
- Two inside patch pockets.

SIZES: S-M, L-XL, 2X-3X, 4X-5X

ANSI/ISEA 107 Class 2 Compliant



1517 & 1519



1509 Lime
1529 Orange **NEW**

Black Bottom Mesh Vest – Economy

PERFORMANCE FEATURES

- Ultra-Cool™ 100% polyester mesh material.
- Solid black polyester on lower front.
- Zipper front closure.
- 2" wide reflective material.
- Left and right chest mic tabs.

POCKETS

- Two lower front solid patch pockets with flaps.
- Left chest radio pocket.
- Right chest 2-tier pocket.
- Two large lower inside pockets.

SIZES: S-M, L-XL, 2X-3X, 4X-5X

ANSI/ISEA 107 Class 2 Compliant



NEW
1527 Lime
1528 Orange

Single Pocket Contrasting Mesh Vest – Economy

PERFORMANCE FEATURES

- 100% polyester mesh.
- Zipper front closure.
- 2" wide reflective material with 3" contrasting color.
- Left chest mic tab.

POCKETS

- Left chest pocket.

SIZES: S-M, L-XL, 2X-3X, 4X-5X

ANSI/ISEA 107 Class 2 Compliant



1519 Lime
1520 Orange

Single Pocket Zipper Mesh Vest – Economy

PERFORMANCE FEATURES

- 100% polyester mesh.
- Zipper front closure.
- 2" wide reflective material.
- Left chest mic tab.

POCKETS

- Left chest pocket.

SIZES: S-M, L-XL, 2X-3X, 4X-5X

ANSI/ISEA 107 Class 2 Compliant



1193 Lime
1194 Orange

Single Pocket Hook & Loop Mesh Vest – Economy

PERFORMANCE FEATURES

- 100% polyester mesh material.
- 4" hook & loop front closure.
- 2" wide reflective material.
- Left chest mic tab.

POCKETS

- Left chest pocket.

SIZES: S-M, L-XL, 2X-3X, 4X-5X

ANSI/ISEA 107 Class 2 Compliant

VESTS

Class 2



1197 Lime
1198 Orange

Combined Performance 5 Pocket Solid Vest

PERFORMANCE FEATURES

- 100% polyester solid material.
- Zipper front closure.
- 2" wide Reflexite® combined performance prismatic reflective material.
- Left chest mic tab.

POCKETS

- Left chest radio pocket with hook & loop strap.
- Right chest 2-tier, 3-division pencil pocket.
- Two lower pockets with zipper closure.
- One large inside lower left patch pocket.

SIZES: S-5X

ANSI/ISEA 107 Class 2 Compliant



1197 & 1198



1076 Lime
1077 Orange

Reflexite® All Mesh Vest

PERFORMANCE FEATURES

- Ultra-Cool™ 100% polyester mesh.
- Zipper front closure.
- 2" wide Reflexite® reflective material.
- Left and right chest mic tabs.

POCKETS

- Outside left chest 2-tier, 4-division pencil pocket.
- Inside lower right patch pocket.

SIZES: S-5X - Small only available in orange.

ANSI/ISEA 107 Class 2 Compliant



1208A Lime
1207A Orange

Reflexite® Solid Front with Mesh Back Vest

PERFORMANCE FEATURES

- Comfortable Ultra-Cool™ 100% polyester mesh material on back with solid front.
- Zipper front closure.
- 2" wide Reflexite® reflective material.
- Left and right chest mic tabs.

POCKETS

- Two lower outside patch pockets with flaps.
- Left chest radio pocket.
- Right chest 4-division pencil pocket.
- Two inside patch pockets.

SIZES: S-5X - Small only available in orange.

ANSI/ISEA 107 Class 2 Compliant

Choose the right material for the right job.



Prismatic ~ Wet conditions

This material reflects back color and utilizes thousands of micro-prisms that are covered by a transparent film. Due to this protective layer, it performs exceptionally well in wet conditions and resists abrasion compared to glass bead.



Glass Bead ~ Warm conditions

Silver glass bead material is made of microscopic glass beads adhered to fabric, which creates a more flexible and lightweight reflective option. While ideal in many environments, especially warm ones, its largest drawback is that it loses reflectivity when wet and can abrade in rough environments.



Your garment's reflective material should stand out from the work environment.

VESTS

Class 3

Meets ANSI standards,
surpasses yours.



1550 & 1242



Premium
Brilliant Series®

1550 Lime
1551 Orange

Heavy Duty Vest

PERFORMANCE FEATURES

- Ultra-Cool™ 100% polyester mesh with solid pockets.
- Brilliant Trim reflective edging improves low light visibility.
- Zipper front closure with durable webbing reinforcement.
- 2" wide CNSS reflective material with 3" Ultra-Cool™ contrasting mesh.
- Left and right chest mic tabs.
- Two lapel grommets.

POCKETS

- Outside right chest 2-tier, 4-division pocket.
- Outside left chest multi-use cell pocket.
- Inside lower patch pockets.
- Two lower outside cargo pockets with flaps and grommets.

SIZES: M-5X

ANSI/ISEA 107 Class 3 Compliant



1242 Lime
1243 Orange

6 Pocket Contrast Mesh Vest

PERFORMANCE FEATURES

- Ultra-Cool™ 100% polyester mesh with solid pockets.
- Zipper front closure.
- 2" wide reflective material with 3" contrasting mesh.
- Left chest mic tab.

POCKETS

- Outside left chest radio pocket.
- Outside right chest 2-tier, 3-division pocket.
- Inside lower patch pockets.
- Two lower outside solid material patch pockets with flaps.

SIZES: M-5X

ANSI/ISEA 107 Class 3 Compliant



ML KISHIGO

The Premium Brilliant Series Difference.



1201A Lime
1202A Orange

Reflexite® Mesh Vest

- PERFORMANCE FEATURES**
- Ultra-Cool™ 100% polyester mesh with solid pockets.
 - 6" hook & loop front closure.
 - 2" wide Reflexite® reflective material.
 - Left and right chest mic tabs.

- POCKETS**
- Outside left chest 2-tier pocket.
 - Outside right chest multi-use cell pocket.
 - Inside lower patch pockets.
 - Two lower outside patch pockets with flaps.

SIZES: S-5X - Small only available in orange.



1264 Lime
1265 Orange

All Mesh Vest – Economy

- PERFORMANCE FEATURES**
- Ultra-Cool™ 100% polyester mesh.
 - Zipper front closure.
 - 2" wide reflective material.
 - Left chest mic tab.

- POCKETS**
- Outside left chest radio pocket.
 - Inside lower right patch pocket.
 - Inside right chest pocket.

SIZES: M-5X

ANSI/ISEA 107 Class 3 Compliant

VESTS

Breakaway

Ready when you need it most.



Breakaway shoulders, sides, and front closure for safety.

Durable webbing reinforcements for tough wear & tear.

Quick access 2-tier divided pocket and left chest multi-use/cell pocket.

Cargo pockets with flaps and grommets for tools.

Brilliant Series reflective trim for visibility in low light conditions.



1552B Lime
1553B Orange

Premium Brilliant Series®

Breakaway Class 3 Vest

PERFORMANCE FEATURES

- Ultra-Cool™ 100% polyester mesh material.
- Brilliant Trim reflective edging improves low light visibility.
- Hook & loop front closure with durable webbing reinforcement.
- 5-Point breakaway on shoulders, sides, and front closure.
- 2" wide CNSS material on 3" contrasting color.
- Left and right chest mic tabs.
- Two lapel grommets.

POCKETS

- Outside right chest 2-tier 4-division pocket.
- Outside left chest multi-use cell pocket.
- Inside lower patch pockets.
- Two lower outside cargo pockets with adjustable flaps and grommets.

SIZES: M-5X

ANSI/ISEA 107 Class 3 Compliant

Designed with you in mind.

When you're on the job, you can't control everything around you. From broken machines to drivers that come a little too close, a job site can be a dangerous place. That's why we created a line that's designed to break away when pulled. You'll lose a panel, but keep so much more.





Contrasting Mesh Breakaway Vest

PERFORMANCE FEATURES

- Ultra-Cool™ 100% polyester mesh.
- Hook & loop breakaway shoulders, sides & front closure.
- 2" wide CNSS reflective material with 4.5" contrasting color.
- Left chest mic tab.

POCKETS

- Inside left chest 2-tier, 4-division pencil pocket.
- Inside lower left patch pocket.
- Inside right chest cell phone pocket.

SIZES: M-5X

ANSI/ISEA 107 Class 2 Compliant

1174 Lime
1176 Orange



4 Season Breakaway Vest

PERFORMANCE FEATURES

- Ultra-Cool™ 100% polyester mesh.
- 4-season adjustability for accurate sizing in any weather even over bulky coats.
- 5-point breakaway.
- Hook & loop front closure.
- Two 1" wide CNSS reflective stripes with 4.5" contrasting color.
- Left chest mic tab.

POCKETS

- Inside right chest 2-tier pencil/cell pocket.
- Two inside lower patch pockets.
- Outside left chest 2-tier pencil pocket.

SIZES: M-XL, 2X-4X

ANSI/ISEA 107 Class 2 Compliant

1166BA Lime
1167BA Orange



Premium Brilliant Series®

Breakaway Vest

PERFORMANCE FEATURES

- Ultra-Cool™ 100% polyester mesh.
- Brilliant Trim reflective edging improves low light visibility.
- 5-point breakaway with breakaway sides, shoulders and front closure.
- 2" wide CNSS reflective material.
- Left chest mic tab.

POCKETS

- Left chest radio pocket.
- Inside lower left patch pocket.
- Inside right chest 2-tier, 4-division pencil pocket.

SIZES: M-5X

ANSI/ISEA 107 Class 2 Compliant

1505B Lime
1506B Orange

VESTS

Specialty

Where innovation meets demand.



1523 Lime
1524 Orange **NEW**

Premium Brilliant Series®

Heavy Duty Vest

PERFORMANCE FEATURES

- Ultra-Cool™ 100% polyester mesh material with Mossy Oak® Break-Up Infinity bottom & trim to keep vest appearance clean & sporty.
- Zipper front closure with durable webbing reinforcement.
- 2" wide breathable reflective material greatly reduces hot spots.
- Reflective piping down sides for added low light visibility.
- Left chest mic tab.

POCKETS

- Two lower outside expandable cargo pockets with flaps.
- Right chest 2-tier, 4-division pocket.
- Left chest gusseted radio/utility pocket with reflective piping.
- Inside lower left heavy duty tablet (iPad) pocket with load-bearing strap.

SIZES: M-5X

ANSI/ISEA 107 Class 2 Compliant
Official Licensed Product of Heas Outdoors, Inc., West Point, MS 39773.
Produced by ML Kishigo

ML KISHIGO



1521 Lime

Premium Brilliant Series®

Ladies Fitted Vest

PERFORMANCE FEATURES

- Ultra-Cool™ 100% polyester mesh back and sides with lightweight solid front.
- Zipper front closure.
- 2" wide CNSS reflective material.
- Reflective trim around arms & piping down sides for added low light visibility.
- Waist cinches to ensure a perfect fit.

POCKETS

- Two hidden lower outside slash pockets with zipper closures.
- Inside ergonomically positioned lower left radio pocket with flap.

LADIES SIZES: S, M, L, XL

ANSI/ISEA 107 Class 2 Compliant



NEW
1525 Lime
1526 Orange

Ladies Mesh Vest – Economy

PERFORMANCE FEATURES

- Ultra-Cool™ 100% polyester mesh.
- Zipper front closure.
- 2" wide reflective material.
- Reflective trim around arms for better visibility in low light conditions.
- Cinched sides to ensure a perfect fit.

POCKETS

- Two lower patch slash pockets.
- Inside lower left radio pocket.

LADIES SIZES: S, M, L, XL

ANSI/ISEA 107 Class 2 Compliant



1521

VESTS

Specialty

Uniquely designed with unparalleled durability.



Reinforced bias trim and padded collar for comfort.

2-tier left pocket can be held up open for quick access.

Inside: Left & right full length zipper pockets for equipment storage.

Left and right paint can pockets with elastic hold downs.

Inside: Heavy duty tablet (iPad) pocket with load bearing strap.

Grommets for flagging tape.

Reflective piping on back for enhanced low light visibility.



Back pouch for maps and instruments.

NEW
S5002 Lime
S5003 Orange

Premium
Black Series®

Surveyors Vest

PERFORMANCE FEATURES

- Solid polyester front with mesh back.
- Heavy duty black bottom and trim to help keep a clean appearance.
- Zipper front closure reinforced with durable webbing.
- 2" wide CNSS reflective material laminated to 3" contrasting color.
- Left and right mic tabs.
- 2 lapel grommets.
- Padded neck for comfort.

POCKETS

- Left chest 2-tier pocket with dual function flap that can be held open by hook & loop.
- Large right gusseted pocket with flap.
- Outside lower front pockets with flaps, left and right stake pockets, left and right elastic spray paint can pockets.
- Lower inside right full length zipper pocket with load bearing strap.
- Lower inside left tablet (iPad) pocket with load bearing strap.
- Hidden back pouch with left and right zipper access.

SIZES: M-5X

(Size medium does not have black trim around arms - Will match garment color).

ANSI/ISEA 107 Class 2 Compliant



Front pockets



Back pouch



Inside pocket



ML KISHIGO



S5000 Lime
S5001 Orange

Class 2: Professional Surveyors Vest

PERFORMANCE FEATURES

- Solid polyester front with mesh back.
- Zipper front closure reinforced with durable webbing.
- 2" wide CNSS reflective material laminated to 3" contrasting color.
- Left and right mic tabs.
- 2 lapel grommets.
- Padded neck for comfort.

POCKETS

- Left chest 2-tier pocket with dual function flap that can be held open by hook & loop.
- Large right gusseted pocket with flap.
- Outside lower front pockets with flaps, left and right stake pockets, left and right elastic spray paint can pockets.
- Lower inside left and right full length zipper pockets with load bearing straps.
- Hidden back pouch with left and right zipper access.

SIZES: M-5X

ANSI/ISEA 107 Class 2 Compliant

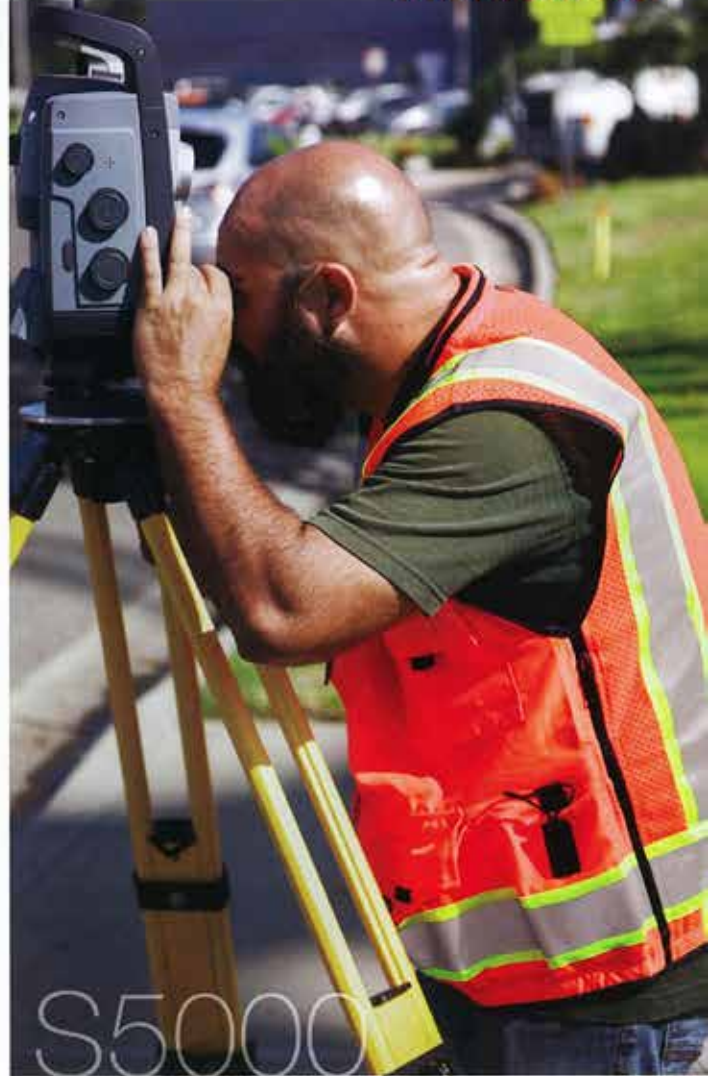

S5000



S5010 Lime
S5011 Orange

Class 3: Professional Surveyors Vest

PERFORMANCE FEATURES

- Solid polyester front with mesh back.
- Zipper front closure reinforced with durable webbing.
- 2" wide CNSS reflective material laminated to 3" contrasting color.
- Left and right mic tabs.
- 2 lapel grommets.
- Padded neck for comfort.

POCKETS

- Same pocket configuration as the Professional Class 2 Surveyors Vest (S5000/S5001) shown above.

SIZES: M-5X

ANSI/ISEA 107 Class 3 Compliant

VESTS

Specialty



T341 Lime

Fall Protection Vest

PERFORMANCE FEATURES

- Durable 100% polyester solid front & Ultra-Cool™ mesh back.
- Snap front closure.
- 2" wide CNSS reflective material on 3" contrasting color.
- Back and side openings for harness rings.
- Left and right chest mic tabs.

POCKETS

- Left chest radio pocket with flap.
- Right chest 2-tier pencil pocket.
- Two lower front expandable-flap closure pockets.
- Two lower inside patch pockets.

SIZES: S-M, L-XL, 2X-3X, 4X-5X

ANSI/ISEA 107 Class 2 Compliant

T341



We've got you covered & tethered.

Working with fall protection manufacturers we developed a functional vest that integrates easy donning, visual inspection of harness, and secure access to D-Rings while maintaining the high visibility your workers need to meet the ANSI standard.

Non ANSI Vests

ML KISHIGO



N Series Mesh Vest

PERFORMANCE FEATURES

- High quality polyester mesh.
- Comfortable cotton trim.
- Three 5/8" wide reflective stripes with 2" contrasting material on back and two on front (N-A1 & NL-A2).
- 3" hook and loop front closure.
- 3/4" elastic side closures for universal sizing.



ONE SIZE FITS MOST

Not ANSI/ISEA Compliant



T Series Mesh Vest

PERFORMANCE FEATURES

- Tightly woven mesh.
- Comfortable cotton trim.
- 1" wide reflective stripes (T-V17 & TL-V18).
- 3" hook and loop front closure.
- 3/4" elastic side closures for universal sizing.



ONE SIZE FITS MOST

Not ANSI/ISEA Compliant

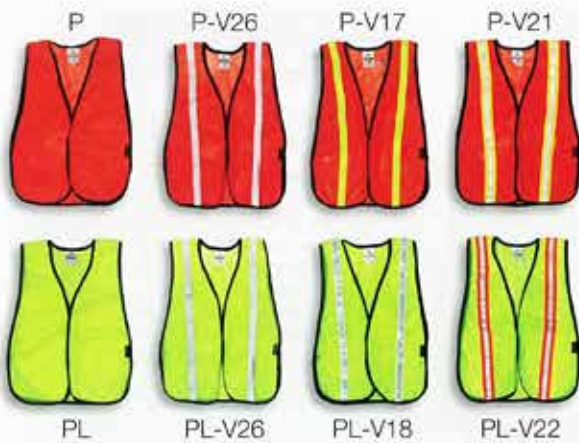

P Series Mesh Vest

PERFORMANCE FEATURES

- Comfortable cotton trim.
- 1" wide reflective stripes (Excluding P & PL).
- 1/2" wide reflective stripes with contrasting material (P-V21 & PL-V22).
- 3" hook and loop front closure.
- 3/4" elastic side closures for universal sizing.



ONE SIZE FITS MOST

Not ANSI/ISEA Compliant



1092 Lime
1091 Orange

Multi-pocket Surveyors Vest – Economy

PERFORMANCE FEATURES

- 100% polyester.
- Zipper front closure.
- 1" wide reflective stripes with 2" wide contrasting material.

POCKETS

- Two lower outside patch pockets with flaps.
- Two outside chest pencil pockets.
- Two inside patch pockets.

SIZES: M-5X

Not ANSI/ISEA Compliant

PANTS

Class E



Premium Brilliant Series®

Mesh Pants

PERFORMANCE FEATURES

- Ultra-Cool™ 100% polyester mesh.
- Brilliant Trim reflective edging considerably improves low light visibility.
- Hook & loop fly with adjustable sides and elastic back.
- 2" wide reflective material with 3" contrasting color.
- Elastic bottom cuff with zipper for boot access.
- Black bottom to help keep a clean appearance.

POCKETS

- Heavy duty solid left and right cargo pockets with reflective piping.
- Left and right side pocket access slits.

SIZES:

S-M Waist - Up to 48" | Inseam - 29"
 L-XL Waist - Up to 54" | Inseam - 32"
 2X-4X Waist - Up to 66" | Inseam - 34"

ANSI/ISEA 107 Class E Compliant

3118 Lime
 3119 Orange

3118



Mesh Pants

PERFORMANCE FEATURES

- Ultra-Cool™ 100% polyester mesh.
- Drawstring waist with elastic back.
- Elastic bottom cuffs
- 3116 & 3117 have zipper cuff for boot access.
- 2" wide reflective material.
- 2" wide Reflexite® prismatic reflective material on 3112 & 3113.

POCKETS

- Left and right side pocket access slits.

SIZES:

S-M Waist - Up to 48" | Inseam - 29"
 L-XL Waist - Up to 54" | Inseam - 32"
 2X-4X Waist - Up to 66" | Inseam - 34"

ANSI/ISEA 107 Class E Compliant

How to make your Class 3 ensemble.



3930 Lime
 3931 Orange

Mesh Gaiters

PERFORMANCE FEATURES

- Ultra-Cool™ 100% polyester mesh.
- Two 2" wide reflective stripes encircle the gaiter.
- Adjustable hook & loop closure.



NEW
 3932 Lime
 3933 Orange

Premium Black Series®

Mesh Gaiters

PERFORMANCE FEATURES

- Ultra-Cool™ 100% polyester mesh.
- 2" wide reflective material with contrasting mesh.
- Zipper closure with hook and loop adjustable bottom for easy boot access.
- Black bottom to help keep clean appearance.



NEW
 3934 Lime
 3935 Orange

Premium Black Series®

Waterproof Gaiters

PERFORMANCE FEATURES

- Waterproof material with durable seam sealed construction to keep you dry and comfortable.
- 2" wide reflective material with contrasting mesh.
- Zipper closure with storm flap and hook and loop adjustable bottom for easy boot access.
- Black bottom to help keep clean appearance.





ML KISHIGO



9114 Lime
9115 Orange

Premium
Black Series®

T-Shirt

PERFORMANCE FEATURES

- Microfiber polyester material wicks away moisture.
- 2" wide reflective breathable tape significantly reduces "hot spots" and provides greater flexibility over solid tapes.
- Black sides provide contrast and add a sporty look.

POCKETS

- Left chest pocket.

SIZES: M-5X

ANSI/ISEA 107 Class 2 Compliant

T-SHIRTS

Class 3 & Non-Ansi



9134



9134 Lime
9135 Orange

Premium
Black Series®

Long Sleeve T-Shirt

PERFORMANCE FEATURES

- Microfiber polyester material wicks away moisture.
- 2" wide reflective breathable tape significantly reduces "hot spots" and provides greater flexibility over solid tapes.
- Black sides provide contrast and add a sporty look.

POCKETS

- Left chest pocket.

SIZES: M-5X

ANSI/ISEA 107 Class 3 Compliant



9122 Lime
9123 Orange

9124 Lime
9125 Orange

Long/Short Sleeve T-Shirt – Economy

PERFORMANCE FEATURES

- Microfiber polyester material wicks away moisture.
- Perfect for protecting your arms from the sun while staying cool.

POCKETS

- Left chest pocket.

SIZES: M-5X

Not ANSI/ISEA Compliant



9128 Lime
9127 Orange

100% Cotton T-Shirt

PERFORMANCE FEATURES

- Lightweight and comfortable all 100% cotton construction.

POCKETS

- Left chest pocket on 9127 (Orange).
- No pocket on 9128 (Lime).

SIZES: S-3X (9127), M-5X (9128)

Not ANSI/ISEA Compliant

Class 2 & 3
ML KISHIGO



9120 Lime
9121 Orange

Flat Stitch Panels Class 2 T-Shirt

PERFORMANCE FEATURES

- Microfiber polyester material wicks away moisture.
- 2" wide CNSS reflective material on contrast panels.
- Flat stitched contrast panels improve daytime visibility and significantly improves comfort and coolness over layered contrasting panels.

POCKETS

- Left chest pocket.

SIZES: M-5X

ANSI/ISEA 107 Class 2 Compliant



9110 Lime
9111 Orange

Short Sleeve Class 2 T-Shirt – Economy

PERFORMANCE FEATURES

- Microfiber polyester material wicks away moisture.
- 2" wide reflective material.

POCKETS

- Left chest pocket.

SIZES: M-5X

ANSI/ISEA 107 Class 2 Compliant



9118 Lime
9119 Orange

Short Sleeve Class 3 T-Shirt

PERFORMANCE FEATURES

- Microfiber polyester material wicks away moisture.
- 2" wide reflective material.

POCKETS

- Left chest pocket.

SIZES: M-5X

ANSI/ISEA 107 Class 3 Compliant



9145 Lime
9146 Orange

Long Sleeve Class 3 T-Shirt – Economy

PERFORMANCE FEATURES

- Microfiber polyester material wicks away moisture.
- 2" wide reflective material.

POCKETS

- Left chest pocket.

SIZES: M-5X

ANSI/ISEA 107 Class 3 Compliant

ACCESSORIES

Better
accessories
for better
visibility.

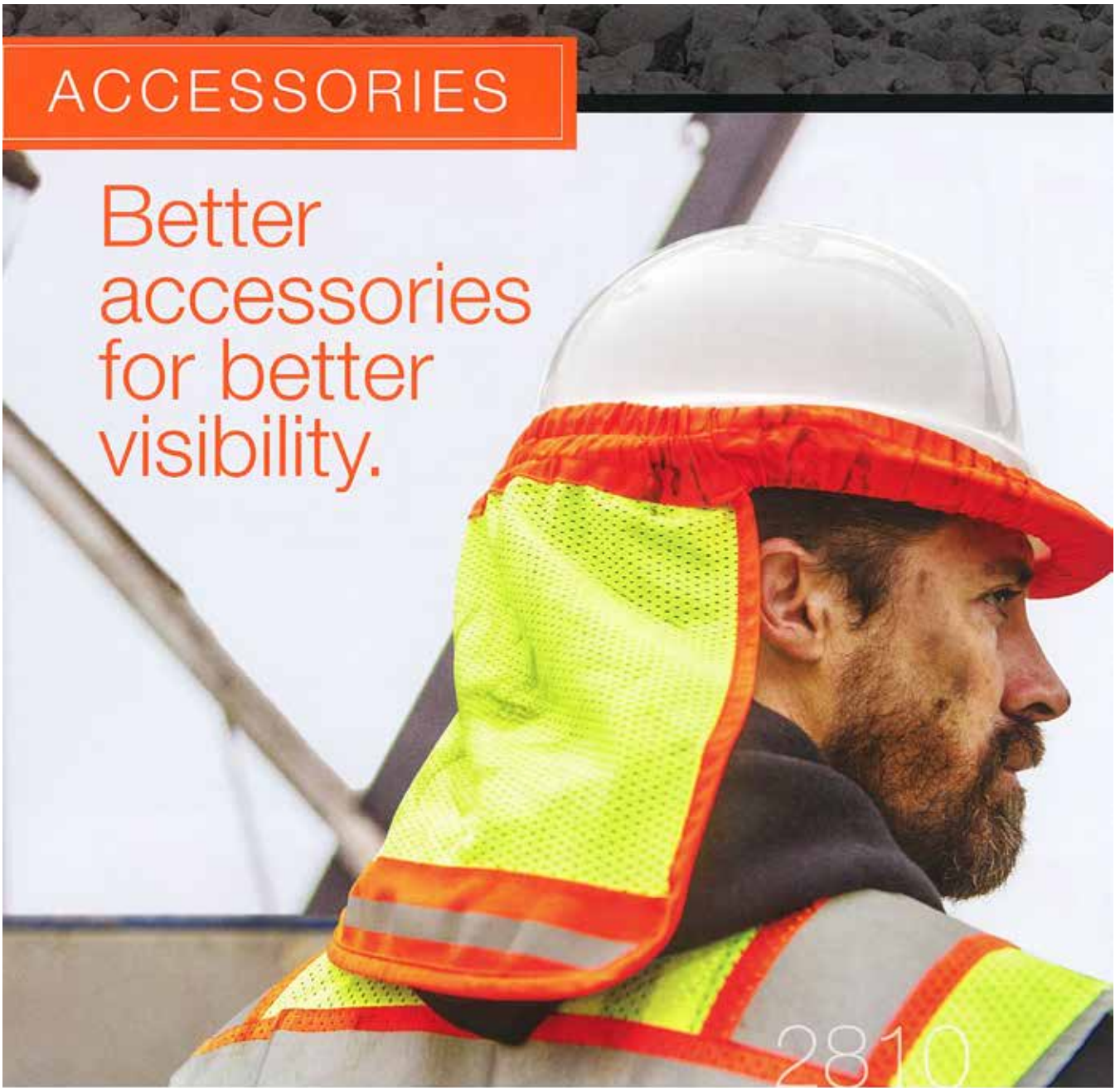

2810 Lime
2813 Orange

Hard Hat Sun Shield

PERFORMANCE FEATURES

- Keeps your neck well shaded.
- Elastic band to fit over most hard hats.
- Ultra-Cool™ 100% polyester mesh with contrasting trim.
- 5/8" wide reflective stripe with contrasting material.

ML KISHIGO



2808 Lime
2809 Orange

Hard Hat Nape Protector

PERFORMANCE FEATURES

- Protects your neck from the sun while wearing your hard hat.
- 100% polyester.
- Self-adhesive hook & loop tabs allow you to attach to the inside or outside of any hard hat.
- 2" wide reflective material.



2-Tone Hard Hat Cover

PERFORMANCE FEATURES

- 100% polyester mesh.
- Elastic band to fit over many different hard hats.
- Built in hooks secure the cover to your hard hat.
- 1" wide reflective material.

ANSI/ISEA 107 Headwear Compliant



2871 Lime/Orange

ACCESSORIES



Knit Beanie

PERFORMANCE FEATURES

- Soft 100% polyester knit material.
- Two stripes of reflective thread are woven into the beanie, allowing for greater flexibility over sewn on reflective tape.



2826 Lime
2827 Orange

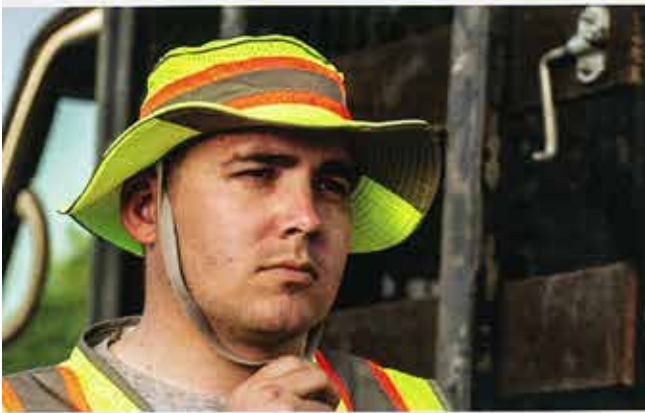

Full Brim Safari Hat

PERFORMANCE FEATURES

- 100% polyester material.
- Mesh around the crown of the head keeps you cool and ventilated.
- 1" wide reflective stripe with 2" contrasting color material 360 degrees around the hat.
- Dark grey under brim reduces glare.
- Reflective piping around brim and top of hat.
- Drawstring keeps the hat securely on your head.



2822 Lime (S-M)
2824 Lime (L-XL)

SIZES: S-M, L-XL

ANSI/ISEA 107 Headwear Compliant

2823 Orange (S-M)
2825 Orange (L-XL)



Baseball Cap

PERFORMANCE FEATURES

- Stylish high visibility baseball cap.
- 100% polyester material.
- 1/2" wide reflective stripes.
- 2 mesh panels on cap for breathability and comfort.
- Dark grey under brim reduces glare.



2854 Lime
2855 Orange

ANSI/ISEA 107 Headwear Compliant



Baseball Cap Sun Shield

PERFORMANCE FEATURES

- Snaps into place on left and right side of our baseball cap.
- Reflective stripe maintains 360 degree visibility around the cap.
- Secure hook & loop tab connects to back strap.
- Baseball cap (2854/2855) sold separately.



2811 Lime
2812 Orange



ML KISHIGO



2816 Lime



OPTIONS TO WEARING SHIELD

Multi-wear Climate Shield

PERFORMANCE FEATURES

- Multiple configurations to fit any style or weather condition.
- Lightweight 100% polyester jersey knit material.
- Two 1" strips of reflective material ensure nighttime or low light visibility in any configuration.

SIZES: One size fits most.

See all the ways to wear at mlkishigo.com/climate-shield.html.



Full Brim Sun Shield

PERFORMANCE FEATURES

- 100% polyester shade with breathable mesh nape protector.
- Designed to fit over full brim hard hats.
- Easy to fold and put away.
- Brilliant Trim reflective material edging improves low light visibility.
- 1/2" reflective stripe with contrasting color.



NEW

2873 Lime

2874 Orange

ACCESSORIES



Single Stripe Seat Belt Covers

PERFORMANCE FEATURES

- High visibility seat belt covers make it easy to ensure your workers are practicing proper safety and are buckled up.
- 1" full length reflective strip.
- Hook and loop closure.

NEW

3902 Lime
3903 Orange



Dual Stripe Seat Belt Covers

PERFORMANCE FEATURES

- High visibility seat belt covers make it easy to ensure your workers are practicing proper safety and are buckled up.
- 2" wide reflective stripes.
- Hook and loop closure.

3901 Lime
3900 Orange



Arm/Ankle Bands

PERFORMANCE FEATURES

- 2" wide elastic arm/ankle band for added visibility.
- Hook & loop adjustability.
- 5/8" wide reflective stripe.

3881 Lime
3882 Orange



Reflective Waist Bands

PERFORMANCE FEATURES

- 2" wide prismatic reflective material belt.
- 2" wide glass bead reflective material on 3895.
- Adjustable up to 54".
- Plastic clasp closure.

3896 Lime
3897 Orange
3895 Silver



ML KISHIGO



Stop Signs



NON-REFLECTIVE

- A. 5950 STOP/SLOW & 5951 STOP/STOP (Not shown).
- 18" Screened hard board.
 - 9" Handle.
- B. 5965 STOP/STOP (Ultra lightweight)
- 18" Screened coroplast.
 - 9" Handle.
 - Ideal for crossing guards.

REFLECTIVE:

- HIGH INTENSITY GRADE**
- D. 5961 STOP/SLOW
- 18" Screened.
 - 12" Handle.
- E. 5963 STOP/SLOW
- 18" Screened.
 - 60" One piece handle.
 - 2 bolt (Assembly required).

REFLECTIVE:

- ENGINEER GRADE**
- C. 5960 STOP/SLOW
- 18" Screened.
 - 12" Handle.

Warning Flags

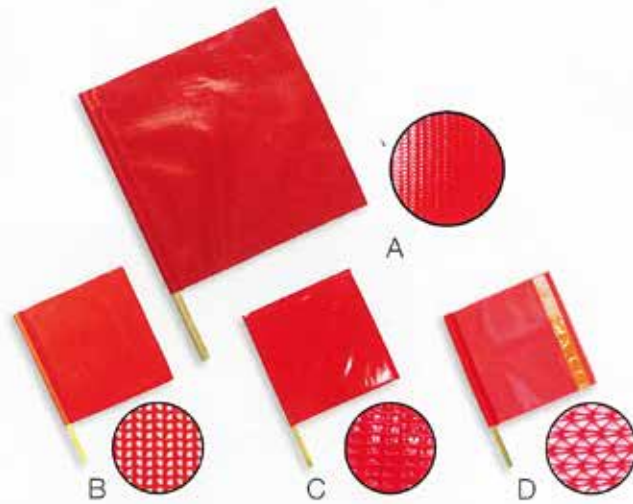

STANDARD WARNING FLAGS

- A. 1600 VINYL
- 18" x 18" red/orange reinforce vinyl material.
 - 3/4" x 24" hardwood dowel.
- B. 1703 MESH
- 18" x 18" red/orange vinyl coated mesh.
 - 3/4" x 24" hardwood dowel.

VINYL FLAG W/ DIAGONAL STAY

- C. 1600S VINYL
- 18" x 18" red/orange vinyl coated material.
 - 3/4" x 24" hardwood dowel.
 - Diagonal stay keeps flag open.

HEAVY DUTY VINYL COATED MESH WITH ORANGE PRISMATIC TAPE

- D. 5988 W/PVC TRIM
- 18" x 18" red/orange 10 oz. vinyl coated mesh.
 - 3/4" x 24" hardwood dowel.
 - 2" wide orange prismatic reflective material.

Overhang Signs



STANDARD WARNING FLAGS

- A. D-5971 MESH
- 18" x 18" fluorescent red/orange 10 oz heavy duty vinyl coated mesh.
 - 12 gauge wire hanger.
- B. CI-5971
- 18" x 18" red lightweight cotton fabric.
 - 12 gauge wire hanger.

OUTERWEAR

Limited Edition

The JS135 is the first of its kind.



Removable high quality zip up hoodie sweatshirt with design inspired reflective bands on the left arm.



Left arm cell phone pocket with waterproof zipper.

Two large integrated outside lower gusseted patch pockets.

Two side access hand warmer pockets with micro fleece lining.



Tape design allows for large logo area on back.

NEW
JS135 Lime

Premium
Black Series®

2 in 1 Jacket

PERFORMANCE FEATURES

- Durable ripstop material with waterproof seam sealed construction.
- 2" wide reflective material laminated directly to the fabric for longer life.
- Zipper front closure with storm flap.
- Removable zip up hoodie sweatshirt.
- Black areas provide contrast, style, and durability.
- Detachable rain hood can be stored in pocket.
- Cuffs with durable rubber pull tabs make for easy adjustments while wearing gloves.
- Ventilated cape back for additional comfort.
- Reflective piping accents on back, sides, and pockets.

POCKETS

- Two outside lower gusseted pockets with hook & loop flaps.
- Two outside lower side access pockets with fleece lining.
- Left chest pocket with retractable ID holder.
- Left arm cell phone pocket with waterproof zipper.
- Inside lower left hidden tablet (iPad) pocket with zipper. Tablet pocket can be accessed without unzipping the jacket.
- Traditional hoodie design with two side slash pockets.

SIZES: M-5X

ANSI/ISEA 107 Class 3 Compliant

Reflective piping accents on back, sides, and pockets help provide early detection for nighttime visibility.



Extra visibility in trim.



ML KISHIGO



Left chest pocket with retractable clear ID holder & cell phone storage.



Hidden tablet pocket.



Durable ripstop material with seam sealed construction.

US135

OUTERWEAR



Premium
Brilliant Series®

Bomber Jacket

PERFORMANCE FEATURES

- Durable waterproof seam sealed shell.
- Removable black quilted liner.
- Hidden collar hood.
- 2" wide 3M™ Scotchlite™ Reflective Material with 3" contrast.
- Reflective piping on collar, shoulders, hood and sleeve seams.
- Adjustable cuffs.
- Black bottom front & sleeves to keep a clean appearance.

POCKETS

- Left chest radio pocket.
- Two outside lower slash pockets with zippers.
- Inside wallet pocket.

SIZES: M-5X

ANSI/ISEA 107 Class 3 Compliant



Bomber Jacket – Economy

PERFORMANCE FEATURES

- Durable waterproof seam sealed shell with thermal insulation.
- 2" wide CNSS reflective material.
- Removable hidden collar hood.

POCKETS

- Two outside slash pockets.
- Left chest radio pocket.
- Right chest outside access multi-use pocket with vertical zipper closure.

SIZES: M-5X

ANSI/ISEA 107 Class 3 Compliant



Fleece Lined Bomber Jacket

PERFORMANCE FEATURES

- Durable waterproof seam sealed shell with fleece liner & fleece lined hood.
- Hood fits into the collar, or can be removed altogether.
- 2" wide CNSS reflective material.
- Adjustable cuffs.

POCKETS

- Right chest vertical zipper wallet pocket.
- Left chest radio pocket.
- Zipper slash side pockets with flaps.

SIZES: M-5X

ANSI/ISEA 107 Class 3 Compliant

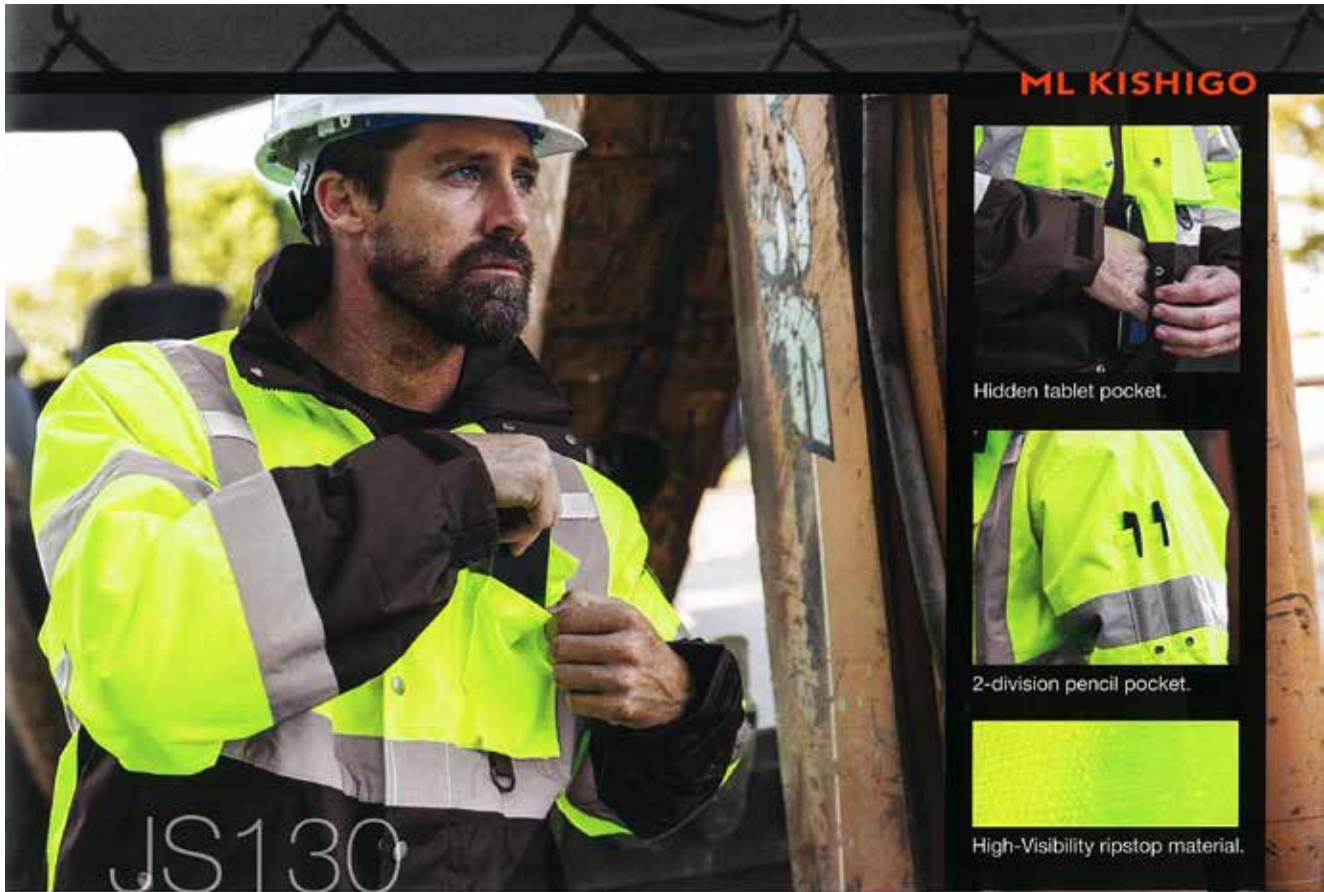

ML KISHIGO

Hidden tablet pocket.

2-division pencil pocket.

High-Visibility ripstop material.



NEW
JS130 Lime

Ripstop Bomber Jacket

PERFORMANCE FEATURES

- Durable waterproof seam sealed ripstop shell with fleece body & hood.
- Hood fits into the collar or can be removed all together.
- Quilted sleeves for easy arm in and out access.
- 2" wide reflective material.
- Adjustable cuffs with rubber pulls for easy use when wearing gloves.
- Left and right mic tabs.

POCKETS

- Right slash vertical pocket for wallet or other accessories.
- Large left radio pocket.
- Left and right outside slash pockets.
- Left bicep 2-division pencil/pen pocket with drainage grommets.
- Large vertical tablet (iPad) pocket with zipper inside storm flap. Tablet can also be accessed without unzipping the jacket.

SIZES: M-5X

M-5X ANSI/ISEA 107 Class 3 Compliant

OUTERWEAR



JS110 Lime
JS111 Orange

- Hidden collar hood.
- Prismatic tape for wet weather.
- Hidden wallet pocket.
- Cell phone pocket.
- Adjustable cuffs to fit over gloves.
- 6" side zipper for easy sitting.
- Storm cuff waist and sleeves (Powder barrier).

360 Pro Series Parka

PERFORMANCE FEATURES

- Reflexite® reflective tape performs exceptionally well under wet conditions and provides additional durability compared to silver glass beaded reflective materials.
- Waterproof seam sealed construction.
- Thermal insulation.
- Hidden collar hood.
- Adjustable cuffs.
- Storm cuff (Powder Barrier) waist and sleeve liners keep wind and snow out of critical areas.
- 6" side zipper for added comfort when sitting and provides improved airflow.
- Black lower body and sleeves help the wearer keep a clean appearance.

POCKETS

- Two outside lower slash pockets with zippers and storm flaps.
- Outside left chest radio pocket.
- Hidden wallet pocket inside front closure storm flap.
- Inside general use pocket.

SIZES: M-5X

ANSI/ISEA 107 Class 3 Compliant

Reflexite®



10110 9 10111

ML KISHIGO



WB100



WB100 Lime
WB101 Orange

Premium
Black Series

Windbreaker

PERFORMANCE FEATURES

- Lightweight 100% polyester and flexible design.
- Durable black ripstop material in high wear areas, along the sides and under the arms.
- Waist cinches hidden in front pockets.
- Adjustable cuffs.
- Shoulder blade vents.
- 2" wide CNSS reflective material.

POCKETS

- Two outside lower pockets with zippers.
- Left chest vertical pocket with waterproof zipper.

SIZES: M-5X

ANSI/ISEA 107 Class 3 Compliant



JS102 Lime
JS103 Orange

Hoodie Sweatshirt with Zipper

PERFORMANCE FEATURES

- Black lower body and sleeves help the wearer keep a clean appearance.
- High quality 9 oz. sweatshirt material.
- Black rib knit cuffing.
- 2" wide CNSS reflective material.

POCKETS

- Lower outside slash pockets.

SIZES: M-5X

ANSI/ISEA 107 Class 3 Compliant

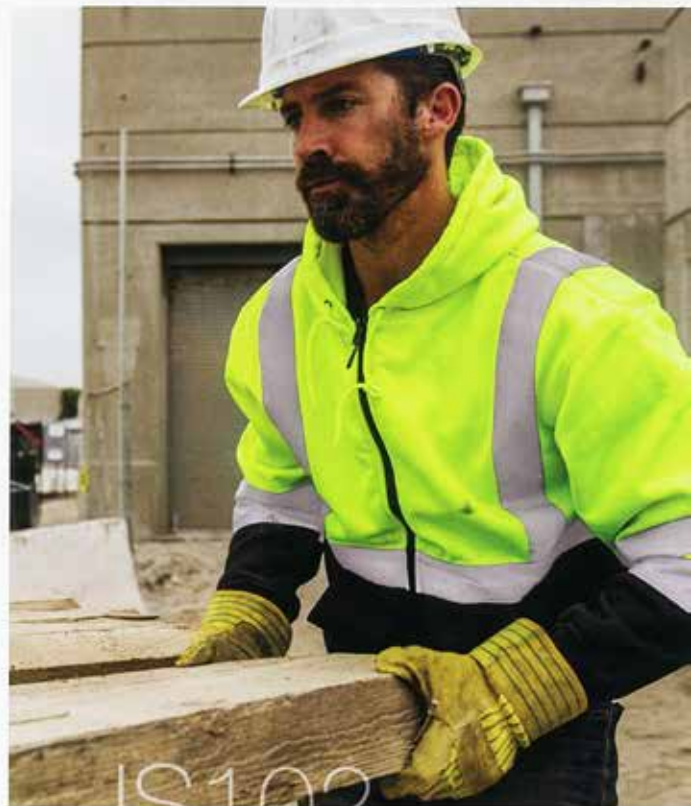

JS102

ML KISHIGO



RWJ106 Lime
RWJ107 Orange

Premium Black Series®

Rainwear

PERFORMANCE FEATURES

- Waterproof breathable material with durable seam sealed construction.
- Black bottom and accents for a mix of functionality and style.
- Reflective trim improves reflectivity all the way around the garment.
- 2" wide Reflexite® reflective material performs exceptionally well under wet conditions.
- Waterproof front zipper.
- Adjustable wrist cuffs.
- Ventilated back and armpits.
- Reinforced D-ring access on back.

POCKETS

- Vertical left chest pocket with waterproof zipper.
- Lower front slash pockets with waterproof zipper.
- Left arm cell phone pocket with storm flap and zipper closure.

SIZES: S-M, L-XL, 2X-3X, 4X-5X

ANSI/ISEA 107 Class 3 Compliant

Rainwear Pants

PERFORMANCE FEATURES

- Reflective trim down the outside of the legs for enhanced low light visibility.
- Adjustable leg cuff straps.
- Zipper cuff for boot access.

POCKETS

- Large left and right side gusseted cargo pockets with reflective trim.

SIZES: S-M, L-XL, 2X-3X, 4X-5X

ANSI/ISEA 107 Class E Compliant

Rainwear Bib

PERFORMANCE FEATURES

Same as pants, plus:

- High quality elastic suspenders with quick release buckle.
- Large chest patch pocket with zipper/storm flap.
- Right side cargo pocket, grommets at the bottom of cargo pocket for water drainage.

SIZES: S-M, L-XL, 2X-3X, 4X-5X

ANSI/ISEA 107 Class E Compliant

Waterproof breathable material and ventilated back and armpits for comfort.

Reflective trim for added visibility in low light and severe weather.

Waterproof zippers and ample easy access pockets throughout.

Prismatic reflective material ideal for wet conditions.

Adjustable cuffs allow for bulky work gloves.

Black bottom and accents for style and clean appearance in dirty conditions.



RWP106 Lime
RWP107 Orange

RWB106 Lime
RWB107 Orange

Reflexite®

RAINWEAR

The material you need with the features you want.



Premium Brilliant Series®

Rainwear

PERFORMANCE FEATURES

- Reflexite® prismatic reflective tape performs exceptionally well under wet conditions, and provides additional durability over glass beaded reflective materials.
- Charcoal material and reflective piping along the shoulders and hood help to identify the human form for greater visibility.
- Waterproof breathable material with durable seam sealed construction.
- Hidden collar hood.
- Zipper/storm flap closure for weather protection.
- Adjustable cuffs.
- Breathable mesh liner.

POCKETS

- Vertical left chest pocket with waterproof zipper.
- Lower outside patch pockets with snap closure.

PANTS

- Right leg cargo pocket.
- Adjustable leg cuff straps.

SIZES: S-M, L-XL, 2X-3X, 4X-5X

ANSI/ISEA 107 Class 3 Compliant - Jacket
ANSI/ISEA 107 Class E Compliant - Pants



ML KISHIGO



Storm Stopper Pro Rainwear

PERFORMANCE FEATURES

- Reflexite® prismatic reflective tape performs exceptionally well under wet conditions, and provides additional durability over silver glass beaded reflective materials.
- Waterproof material with seam sealed construction keeps the wearer warm and dry.
- Black lower body and sleeves help keep the wearer's appearance neat and clean.
- Vented cape back for additional breathability.
- Hidden collar hood.
- Adjustable wrist and ankle cuffs.
- Mesh liner.
- D-ring access on back.

POCKETS

- Two outside pockets with storm flaps and snaps.
- Left chest radio pocket.

PANTS

- Adjustable leg cuff straps.

SIZES: S-M, L-XL, 2X-3X, 4X-5X

ANSI/ISEA 107 Class 3 Compliant - Jacket
ANSI/ISEA 107 Class E Compliant - Pants

RWJ100 Lime
RWJ101 Orange

RWP100 Lime
RWP101 Orange

Premium Brilliant Series®

Long Rain Coat

PERFORMANCE FEATURES

- Waterproof material with durable seam sealed construction.
- 2" wide CNSS reflective material.
- Reflective piping on shoulders, hood and sleeve seams.
- Zipper/storm flap closure for weather protection.
- Non-sparking snaps and zipper.
- Adjustable wrist cuffs.
- Black lower body and sleeves help keep the wearer's appearance neat and clean.

POCKETS

- Lower front patch pockets with flaps.

SIZES: S-M, L-XL, 2X-3X, 4X-5X

ANSI/ISEA 107 Class 3 Compliant



RWJ108 Lime
RWJ109 Orange



Reflexite®

RAINWEAR

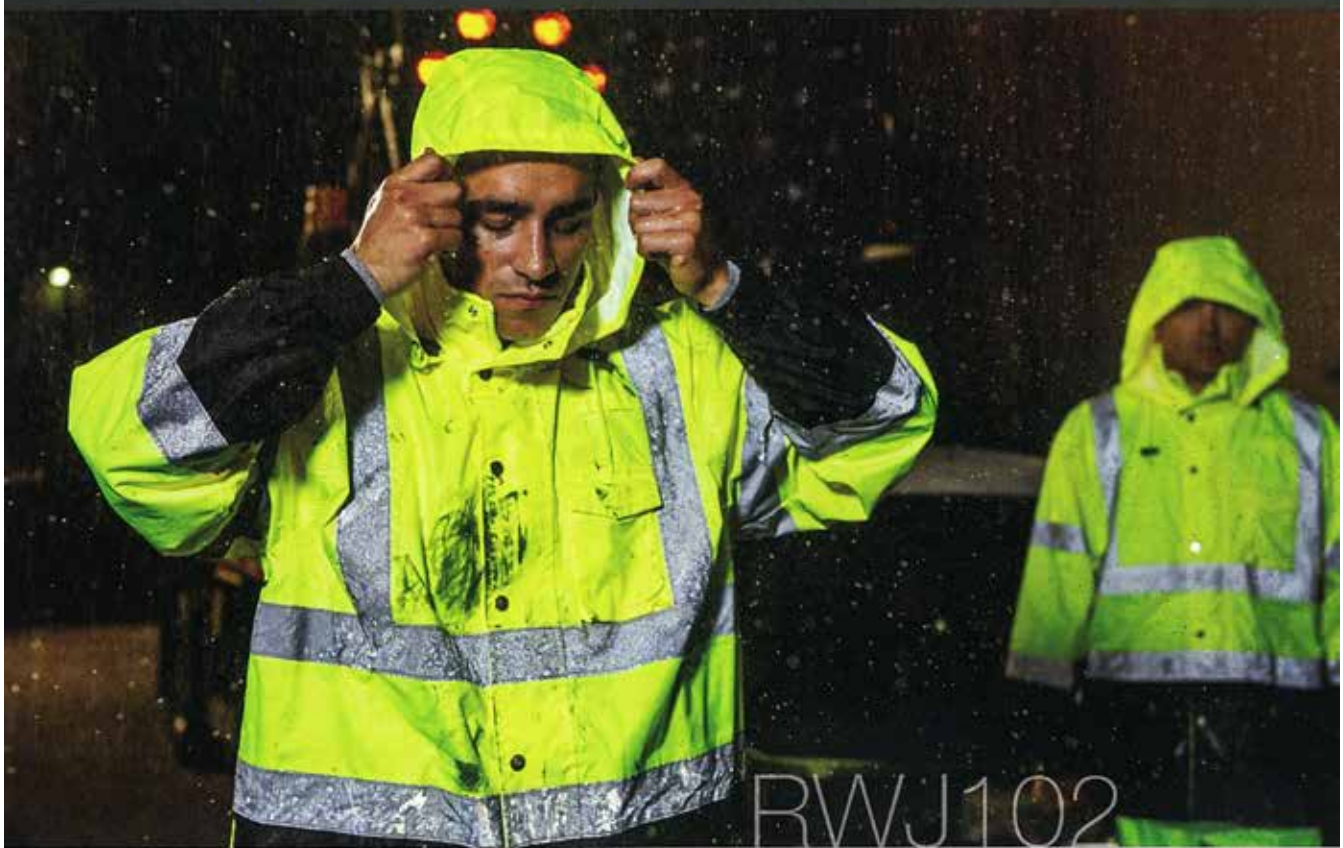

RWJ102



Storm Cover Rainwear

PERFORMANCE FEATURES

- Waterproof material with durable seam sealed construction.
- 2" wide CNSS reflective material.
- Zipper/storm flap closure for weather protection.
- Non-sparking snaps and zipper front closure.
- Adjustable wrist cuffs.
- Mesh liner.

POCKETS

- Lower front patch pockets with snap closure.
- Left chest radio pocket.

PANTS

- Adjustable leg cuff straps.

SIZES: S-M, L-XL, 2X-3X, 4X-5X

ANSI/ISEA 107 Class 3 Compliant - Jacket
ANSI/ISEA 107 Class E Compliant - Pant

RWJ102 Lime
RWJ103 Orange

RWP102 Lime
RWP103 Orange



Storm Stopper Rainwear

PERFORMANCE FEATURES

- Waterproof material with durable seam sealed construction.
- 2" wide CNSS reflective material.
- Zipper/storm flap closure.
- Non-sparking snaps and zipper.
- Fully vented cape back for breathability.
- Adjustable wrist cuffs.
- Mesh liner.

POCKETS

- Patch pockets with snap closure.

BIB

- High quality elastic suspenders with quick release buckle.
- Adjustable leg cuff straps.
- Front fly with snap closure.

SIZES: S-M, L-XL, 2X-3X, 4X-5X

ANSI/ISEA 107 Class 3 Compliant - Jacket
ANSI/ISEA 107 Class E Compliant - Bib



Rainwear Set – Economy

Full rainsuit only. No separates.

PERFORMANCE FEATURES

- Waterproof material with durable seam sealed construction.
- 2" wide CNSS reflective material.
- Zipper/storm flap closure.
- Non-sparking snaps and zipper.
- Adjustable wrist cuffs.

POCKETS

- Lower front patch pockets with flaps.

PANTS

- Adjustable leg cuff straps.

SIZES: S-M, L-XL, 2X-3X, 4X-5X

ANSI/ISEA 107 Class 3 Compliant - Jacket
ANSI/ISEA 107 Class E Compliant - Pants

Index

- 131B Pole Mounting Bracket, #UT-T648-1, **C-6**
- 3-Pocket Pouch for Fiber Workstation, #55710, **A-3**
- 45A Bracket, #UT-T639-1, **C-5**
- 51B Hanger Brackets, 3.5" X 22", #UT-T556-5, **C-5**
- 51B Hanger Brackets, 3.5" X 27.5", #UT-T556-1, **C-5**
- 51B Hanger Brackets, 3.5" X 33", #UT-T556-2, **C-5**
- 51B Hanger Brackets, 3.5" X 40", #UT-T556-4, **C-5**
- 51B Hanger Brackets, 5.5" X 40", #UT-T556-3, **C-5**
- 5-Pocket Tool Pouch, #39401-5, **L-1**
- 6-Pocket Tool Pouch, #39401-6, **L-1**
- Adhesive/Caulk, tube, #8ADHESIVE-W, **O-2**
- Aerial Strands for Fiber Workstation, #55715, **A-3**
- Aerial Strand Mounting Bracket, 37", #UT-T556-21, **C-6**
- Aerial Strand Mounting Bracket, 40", #UT-T556-22, **C-6**
- Attic-Trax Walk Board, #62028, **N-1**
- B Insulator Support Clamp, #UT-B1420, **C-6**
- Backboards, Exterior, **C-4**
- Backboards, Interior, **C-1, 2, 3**
- Blowers, Portable, **F-1, 2, 3**
 - Ventilator, 1500, #A-1500, **F-1**
 - Ventilator, 1500-23, #A-1500-230, **F-1**
 - Ventilator, 3000, #A-3000, **F-1**
 - Ventilator, Pneumatic, 3000P, #A-3000P, **F-2**
 - Ventilator, High-capacity, 8000, #A-8000, **F-2**
 - Ventilator, Master 8" Confined Space, #M08-25, **F-3**
- Ducts, **F-3**
 - Ventilator Duct with Quick Connect, 8" dia. X 15' Length, #A-0815, **F-3**
 - Ventilator Duct with Quick Connect, 8" dia. X 25' Length, #A-0825, **F-3**
 - Ventilator Duct with Quick Connect, 12" dia. X 15' Length, #A-1215, **F-3**
 - Ventilator Duct with Quick Connect, 12" dia. X 25' Length, #A-1225, **F-3**
- Coupler, **F-3**
 - Ventilator Duct Coupler, 8" dia., #A-8000, **F-3**
- Storage Rack, **F-3**
 - Duct Storage Rack, metal, 8" dia. X 25' Length, #UTDSR-25-08, **F-3**
 - Duct Storage Rack, metal, 12" dia. X 25' Length, #UTDSR-25-12, **F-3**
 - Duct Storage Rack, polyethylene, 8" dia. X 25' Length, #UTDSR-25-08P, **F-3**
 - Duct Storage Rack, polyethylene, 12" dia. X 25' Length, #UTDSR-25-12P, **F-3**
- Brackets, **C-5, 6**
 - 131B Pole Mounting Bracket, #UT-T648-1, **C-6**
 - 45A Bracket, #UT-T639-1, **C-5**
 - 51B Hanger Brackets, 3.5" X 22", #UT-T556-5, **C-5**
 - 51B Hanger Brackets, 3.5" X 27.5", #UT-T556-1, **C-5**
 - 51B Hanger Brackets, 3.5" X 33", #UT-T556-2, **C-5**
 - 51B Hanger Brackets, 3.5" X 40", #UT-T556-4, **C-5**
 - 51B Hanger Brackets, 5.5" X 40", #UT-T556-3, **C-5**
 - Aerial Strand Mounting Bracket, 37", #UT-T556-21, **C-6**
 - Aerial Strand Mounting Bracket, 40", #UT-T556-22, **C-6**
 - E Wall Bracket, #UT-T639-3, **C-6**
 - Fiber Snowshoe Mounting Hardware, UT-U500-1, **C-5**
 - S Wall Bracket, #UT-T639-4, **C-6**
 - Wall Mounting Brackets, MC10/48 1", #UT-T484-1, **C-5**
 - Wall Mounting Brackets, MC10/48 2", #UT-T484-2, **C-5**
 - Wall Mounting Brackets, MC10/48 3", #UT-T484-3, **C-5**
 - Wall Mounting Brackets, MC10/48 4", #UT-T484-4, **C-5**
 - Wall Mounting Brackets, MC10/48 5", #UT-T484-5, **C-5**
 - Wall Mounting Brackets, MC10/48 6", #UT-T484-6, **C-5**
- Buried Closure Protective Housing, **I-1**
- C Beam Clamp, #UT-T5887, **C-6**
- C Insulator Support Clamp, #UT-C3816, **C-6**
- Cable & Wire Storage Box, #59100, **L-1**
- Cable Protector, Temporary, Plastic, #55560, **G-1**

Cable Protector, Temporary, Rubber, #55550, **G-1**

Carrying Case for Emergency Worklight, #41000-CC, **D-1**

Certification and Calibration Program, Total Support System for Gas Detectors, **E-9**

Chain Hoist, **N-3**

3/4 ton, 5 ft. lift, 11 in. lever, #U187707, **N-3**

3/4 ton, 10 ft. lift, 11 in. lever, #U187708, **N-3**

1-1/2 ton, 5 ft. lift, 17 in. lever, #U187711, **N-3**

1-1/2 ton, 10 ft. lift, 17 in. lever, #U187712, **N-3**

3 ton, 5 ft. lift, 17 in. lever, #U187715, **N-3**

3 ton, 10 ft. lift, 17 in. lever, #U187716, **N-3**

Clamps, **C-6**

B Insulator Support Clamp, #UT-B1420, **C-6**

C Insulator Support Clamp, #UT-C3816, **C-6**

C Beam Clamp, #UT-T5887, **C-6**

Dielectric Umbrella, 7-1/2', Non-tilt, with tripod, #73075Y, **M-1**

Dielectric Umbrella, 7-1/2', Non-tilt, with window and tripod, #73075CY, **M-1**

Dielectric Umbrella, 7-1/2', Tilt, with tripod, #73075YT, **M-1**

Dielectric Umbrella, 7-1/2', Tilt, with window and tripod, #73075CYT, **M-1**

Dielectric Umbrella Bag, #73007-BAG, , **M-2**

Duct Storage Rack, metal, 12" dia. X 25' Length, #UTDSR-25-12, **F-3**

Duct Storage Rack, metal, 8" dia. X 25' Length, #UTDSR-25-08, **F-3**

Duct Storage Rack, polyethylene, 12" dia. X 25' Length, #UTDSR-25-12P, **F-3**

Duct Storage Rack, polyethylene, 8" dia. X 25' Length, #UTDSR-25-08P, **F-3**

E Wall Bracket, #UT-T639-3, **C-6**

Emergency Worklight Kit, #41000, **C-1**

Emergency Worklight System Complete Kit, #41000-LC, **C-1**

Ergo Seat, #55430-SS, **A-2**

Ergo Seat with Pocket, #55430-SS-POC, **A-2**

Extension Cord for Emergency Worklight, #47555-50, **C-1**

Extra Bulb set for Emergency Worklight, #40500-2, **C-1**

Fiber Optic Protector Sleeves, #55501, **A-2**

Fiber Optic Splicing Workstation, #55701, **A-3**

Fiber Snowshoe Mounting Hardware, #UT-T500-1, **C-5**

Gas Detectors, **E-1, 8**

Personal Monitors

P100, **E-1, 2**

P400, **E-3, 4**

Combustible Gas Detectors

Sensit Gold G2 (LEL), **E-5, 6**

Sensit HXG-2d, **E-7, 8**

Service

Support & Service, Total Support System, **E-9**

Handi Hoist Lift System, #55810, **N-3**

Hook Stakes, 100/box, #74000, **O-2**

Insulator Support Clamps, B, #UT-B1420, **C-6**

Insulator Support Clamps, C, #UT-C3816, **C-6**

Joining Strip, 4" x 25', green, #74403-G, **O-2**

Ladder Caddy, #59501-C, **J-2**

Ladder Wedge, **J-1**

Ladder Wedge, Yellow, Metal Cleats, #55429-P-M, **J-1**

Ladder Wedge, Yellow, Rubber Cleats, #55429-P-R, **J-1**

Ladder Wedge, Orange, Metal Cleats, #55429-Por-M, **J-1**

Ladder Wedge, Orange, Rubber Cleats, #55429-Por-R, **J-1**

LED Dual Power Light with Magnifying Glass for Splicer Table, #55615, **A-3**

LED Portable Worklight, High-Power, #UT-L-1323, **D-3**

LED Portable Worklight, Rechargeable, #UT-L-1320, **D-3**

Locator Vest, **K-1**

Pack Rat Locator Vest, Class 2 Original, Orange, #60001, **K-1**

Pack Rat Locator Vest, Class 2 Original, Yellow, #60002Y, **K-1**

Pack Rat Locator Vest, Class 2 Mesh, Orange, #60021, **K-1**

Pack Rat Locator Vest, Class 2 Mesh, Yellow, #60022Y, **K-1**
 Pack Rat Locator Vest, Class 3 5-Point Breakaway, Orange, #60031, **K-1**
 Pack Rat Locator Vest, Class 3 5-Point Breakaway, Yellow, #60032Y, **K-1**
 Magic Wrap, 1" X 16', #UT-80001, **A-4**
 Magic Wrap, 2" X 16', #UT-80031P, **A-4**
 Manual Staple Gun, #74200, **O-2**
 Mat for Splicer Seat, #55430-MAT, **A-1**
 Micro-Trench Clips, 1000/box, #55310, **H-1**
 Micro-Trench Clip Insertion Tool, #55300, **H-1**
 Micro-Trench Tamper Tool, #55400, **H-1**
 P100 Personal Gas Detector, **E-1, 2**
 P400 Personal Gas Detector, **E-3, 4**
 Pack Rat Locator Vest, Class 2 Mesh, Orange, #60021, **K-1**
 Pack Rat Locator Vest, Class 2 Mesh, Yellow, #60022Y, **K-1**
 Pack Rat Locator Vest, Class 2 Original, Orange, #60001, **K-1**
 Pack Rat Locator Vest, Class 2 Original, Yellow, #60002Y, **K-1**
 Pack Rat Locator Vest, Class 3 5-Point Breakaway, Orange, #60031, **K-1**
 Pack Rat Locator Vest, Class 3 5-Point Breakaway, Yellow, #60032Y, **K-1**
 Ped-Mat, **O-1, 2**
 Ped-Mat #1, 3' X 4', round perms, green, #74001-G, **O-1, 2**
 Ped-Mat #2, 3' X 4', square/rectangle perms, green, #74002-G, **O-1, 2**
 Ped-Mat #3, 3' X 4', no perms, green, #74003-G, **O-1, 2**
 Installation Accessories, **O-2**
 Joining Strip, 4" x 25', green, #74403-G, **O-2**
 Hook Stakes, 100/box, #74000, **O-2**
 Staples, 2000/box, #74100, **O-2**
 Manual Staple Gun, #74200, **O-2**
 Adhesive/Caulk, tube, #8ADHESIVE-W, **O-2**
 Pole Mounted Ladder Bracket, Almond, #55900-001, **J-3**
 Pole Mounted Ladder Bracket, Green, #55900-002, **J-3**
 Pole Mounted Ladder Bracket, Brown, #55900-003, **J-3**
 Reel-Deal Cable Caddy, #59000, **L-2**
 Reel-Deal Cable Caddy, Single Pull Line #59011, **L-2**
 Retro Fit Kit, #55430-RETROKIT, **A-1**
 Rung Runner Ladder Caddy, #59501-C, **J-2**
 S Wall Bracket, #UT-T639-4, **C-6**
 Safe-T Lid Temporary Covers, **N-2**
 For Manholes, **N-2**
 Safe-T Lid Temporary Covers for Manholes, 24" dia., #28024-Y, **N-2**
 Safe-T Lid Temporary Covers for Manholes, 28" dia., #28028-Y, **N-2**
 Safe-T Lid Temporary Covers for Manholes, 32" dia., #28032-Y, **N-2**
 For Handholes, **N-2**
 Safe-T Lid Temporary Covers for Handholes, 24" X 36", #282436-Y, **N-2**
 Safe-T Lid Temporary Covers for Handholes, 30" X 48", #283048-Y, **N-2**
 SealGuard II Kit , **I-2**
 Seat Cover for Splicer Seat, #55430-COVER, **A-1**
 Sensit Gold G2 (LEL) Gas Detector, **E-5, 6**
 Sensit HXG-2d Combustible Gas Detector, **E-7, 8**
 Splice Adapter, 710 for Splicer Seat, #55500, **A-1**
 Splice Adapter, MS2 (3M) for Splicer Seat, #55420, **A-1**
 Splicer Seat, **A-1**
 Splicer Seat, Grey, #55430, **A-1**
 Splicer Seat, Orange, #55430-OR, **A-1**
 Splicer Seat Accessories, **A-1**
 MS2 (3M) Splice Adapter, #55420, **A-1**
 710 Splice Adapter, #55500, **A-1**
 Tool Base Adapter, #55450, **A-1**
 Tool Saddle with Pockets, #55430-CU-BLK, **A-1**
 Mat, 3' X 4', #55430-MAT, **A-1**
 Splicing Arm Base, #55430-BASE, **A-1**
 Universal Splicing Head Adapter, #55460, **A-1**
 Retro Fit Kit, #55430-RETROKIT, **A-1, A-2**
 Seat Cover, #55430-COVER, **A-1**
 Tool Pouch, #55430-POC-A, **A-1**

Splicer Table

Fiber Optic Splicing Workstation, #55701, A-3

Accessories, A-3

Aerial Strands, #55715, A-3

Black Poly-mesh 3-Pocket Pouch, #55710, A-3

LED Dual Power Light for Fiber Optic Splicing Workstation, #55615, A-3

Splicing Arm Base for Splicer Seat, #55430-BASE, A-1

Staples, 2000/box for Ped-Mat, #74100, O-2

Step Runner Ladder Caddy, #59501-STP, J-3

Storage Box, Cable & Wire Storage Box, #59100, L-1

Suction Mount for Work & Dielectric Umbrella, #730MNT, M-2

Temporary Fiber Drop Marker, #55360, B-1

Tool Base Adapter for Splicer Seat, #55450, A-1

Tool Pouch for Splicer Seat, #55430-POC-A, A-1, A-2

Tool Pouches, L-1

5-Pocket Tool Pouch, #39401-5, L-1

6-Pocket Tool Pouch, #39401-6, L-1

Tool Saddle with Pockets for Splicer Seat, #55430-CU-BLK, A-1

Tripod Stand, for Umbrella, #730TRI, M-2

Umbrellas, M-1

Work, M-1

Work Umbrella, 5-1/2 Non-tilt, #73005, M-1

Work Umbrella, 6' Non-tilt, #73006, M-1

Work Umbrella, 7' Non-tilt, #73007, M-1

Work Umbrella, 5-1/2' Tilt, #73005-T, M-1

Work Umbrella, 6' Tilt, #73006-T, M-1

Work Umbrella, 7' Tilt, #73007-T, M-1

Dielectric, M-1

Dielectric Umbrella, 7-1/2', Non-tilt, with window and tripod, #73075CY, M-1

Dielectric Umbrella, 7-1/2', Non-tilt, with tripod, #73075Y, M-1

Dielectric Umbrella, 7-1/2', Tilt, with window and tripod, #73075CYT, M-1

Dielectric Umbrella, 7-1/2', Tilt, with tripod, #73075YT, M-1

Accessories

Dielectric Umbrella Bag, #73007-B, M-2

Suction Mount, #730MNT, M-2

Umbrella Adjustable Tripod Stand, #730TRI, M-2

Work Umbrella Bag, #73007-B, M-2

Universal Splicing Head Adapter for Splicer Seat, #55460, A-1

Utility Pole Mat, 22' X 22', green, #76022K-G, O-2

Wall Mounting Brackets, MC10/48 1", #UT-T484-1, C-5

Wall Mounting Brackets, MC10/48 2", #UT-T484-2, C-5

Wall Mounting Brackets, MC10/48 3", #UT-T484-3, C-5

Wall Mounting Brackets, MC10/48 4", #UT-T484-4, C-5

Wall Mounting Brackets, MC10/48 5", #UT-T484-5, C-5

Wall Mounting Brackets, MC10/48 6", #UT-T484-6, C-5

Wheel Chock, hardwood with metal handle, #63001, N-1

Wheel Chock, hardwood with steel tread and metal handle, #63002, N-1

Work Umbrella Bag, #73007-B, M-2

Work Umbrella, 5-1/2 Non-tilt, #73005, M-1

Work Umbrella, 5-1/2' Tilt, #73005-T, M-1

Work Umbrella, 6' Non-tilt, #73006, M-1

Work Umbrella, 6' Tilt, #73006-T, M-1

Work Umbrella, 7' Non-tilt, #73007, M-1

Work Umbrella, 7' Tilt, #73007-T, M-1

Work Lights, D-1

Emergency Worklight System Complete Kit, #41000-LC, D-1

Emergency Worklight Kit, #41000, D-1

Accessories, D-1

Extra Bulb set for Emergency Worklight, #40500-2, D-1

Extension Cord for Emergency Worklight, #47555-50, D-1

Carrying Case for Emergency Worklight, #41000-CC, D-1

LED Portable Worklight, Rechargeable, #UT-L-1320, D-1

LED Portable Worklight, High-Power, #UT-L-1323, D-1

Workwear, ML Kishigo Safety Vests, Hats, rainwear shirts, etc., P-1 to 42



For additional information on these products contact our customer service
at **(800) 542-7011** or visit us on the web at **UTECK.com**

To receive additional copies of this literature, please ask for: U-TECK Catalog - REV 01/02/19